



# Expansion Joint Covers





Parkland Hospital  
Architects: HDR & Corgan



Corporate Headquarters  
Architects: VCBO Architecture



California Memorial Stadium  
Architects: HNTB  
& STUDIOS Architecture

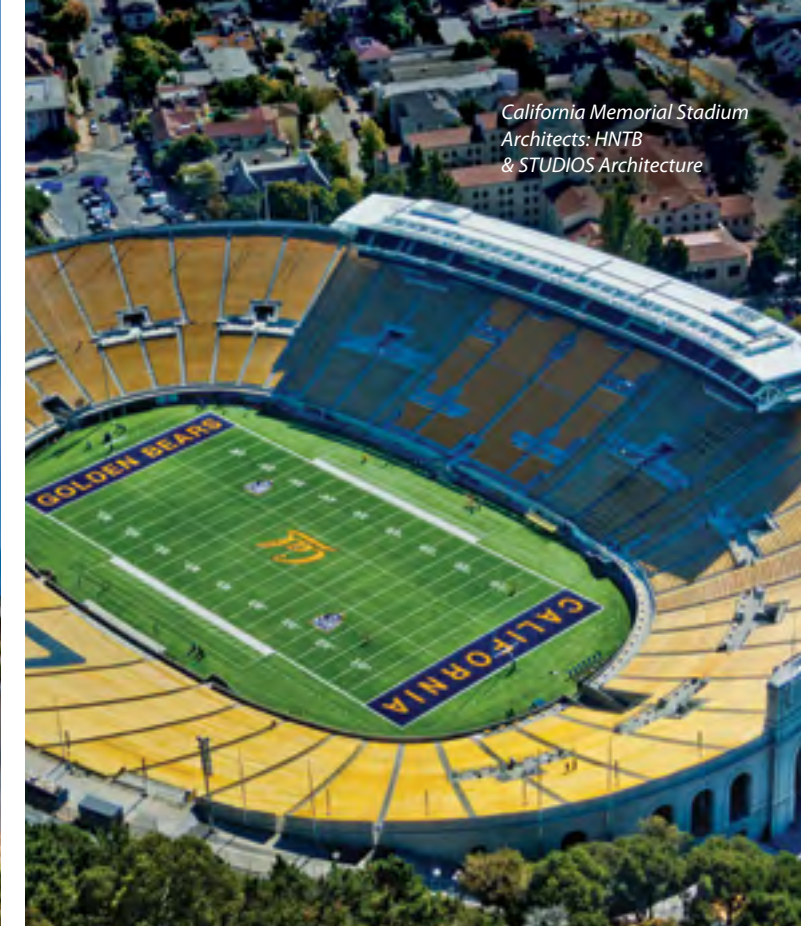

Cathedral of Christ the Light  
Architect: Skidmore, Owings & Merrill

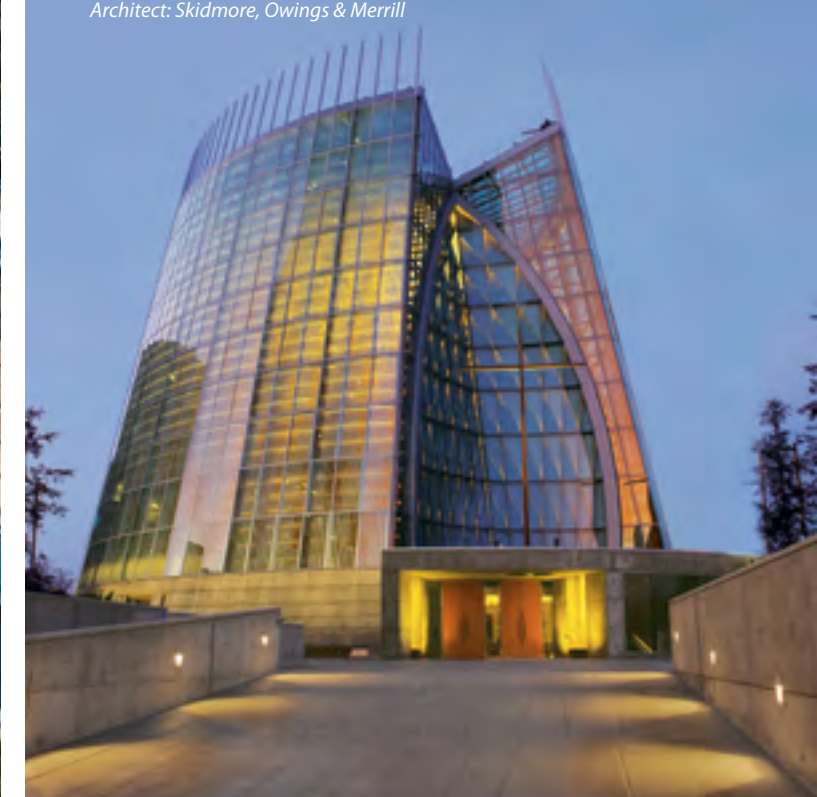

C / S EXPANSION JOINT COVERS

# Solving complex movement problems for over 45 years

City Center  
Architect: HKS Architects



Fulton Street Transit Center  
Architect: Grimshaw Architects



City Creek Center  
Architects: ZGF Architects LLP, Callison, Hobbs+Black  
Architects, FFKR Architects & SWA Group

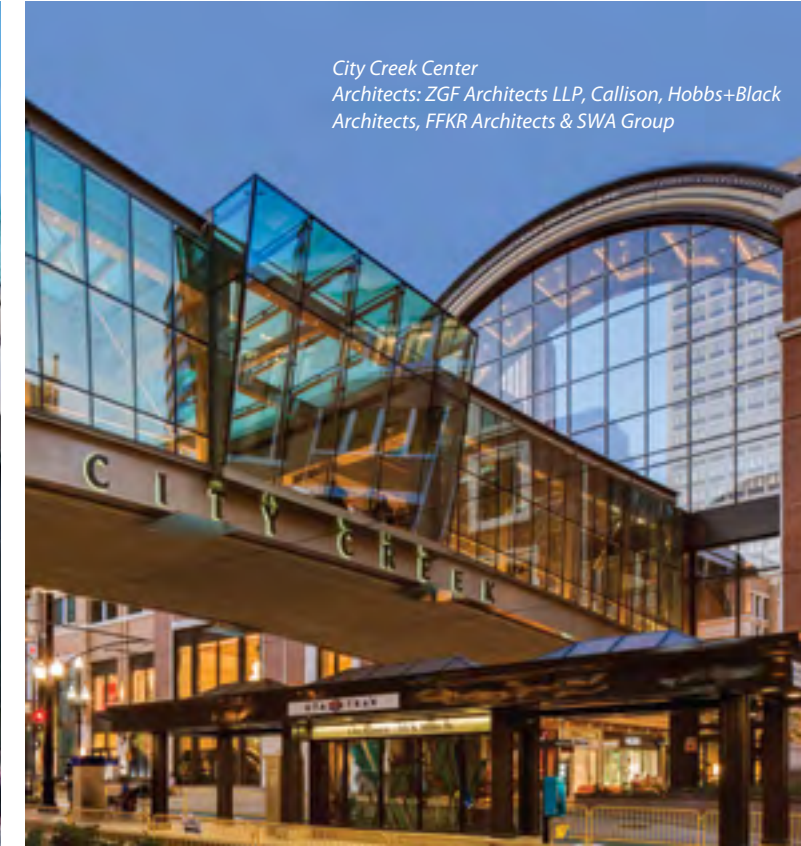

Adobe Utah Campus  
Architect: WRNS Studio







## C/S can make even the biggest joints disappear.

Large seismic joints are necessary in today's architecture, and unfortunately, they can destroy even the finest interior and exterior designs. C/S has dedicated itself to becoming a master at hiding joints by developing a range of covers that are virtually invisible in order to empathize with the architect's design intent.



### Interior and Exterior Joint Covers at Norman Y. Mineta San Jose International Airport

Gensler did not want its design for the San Jose airport to be interrupted by obtrusive expansion joint covers inside or out. For the exterior, Gensler called on C/S to incorporate 25" XLS covers within the 34" wide CENTRIA metal panels, making them disappear in the roof structure.



### Interior Joint Covers at John Wayne Airport, Orange County (SNA), CA, Terminal C

Located in a seismic area, the airport's new terminal 'C' required massive 28" expansion joint covers. To prevent the joint covers from ruining the building's sleek design, Gensler specified the C/S LAF covers for the airport's ceiling and customized XLS interior covers for the walls.



THE C/S DIFFERENCE

*C/S prides itself on delivering the highest quality products.*



C/S' modular pan's design eliminates deflection and cracking.

Exclusive Delrin® bearing allows cover to move smoothly and prevents binding, unlike covers using metal to metal components.

C/S' virtually invisible covers can be installed in interior or exterior applications. The covers' modular pans can include any flooring material.

C/S offers the industry's largest joint cover widths.

C/S' exclusive edge protection eliminates chipping and cracking of pavers.

C/S' gravity-activated turnbar returns cover smoothly to normal position after an event.

**Exclusive cutting-edge wall cover system**



Multi-directional seismic forces can play havoc with conventional turnbars, especially in wall covers. Following the damage assessment from the Northridge quake, C/S designed a wall cover that disengages during a seismic event (tethered to prevent falling) to protect the surrounding finishes from damage.



**XLS Exterior Wall Cover**

This exclusive cover allows large seismic joints to be concealed within exterior cladding. The key to this system is the innovative gravity closing system that automatically reseals the cover after a seismic event. The cover can receive a wide variety of cladding systems including metal, glass and stone and is available in environmentally friendly powder coat finishes.

*Choose the right cover, choose C/S.*



# Whatever criteria your project calls for, C/S can create a cover to meet it.

C/S has been helping architects solve complex building movement problems for over 45 years. Since every project has its own special movement criteria, one of C/S' standard designs may not be right for your project. **A large percentage of our projects require custom expansion joint covers.**

**C/S' team of technical experts can design a custom cover to meet your project's specific requirements.** And with the industry's only full-scale expansion joint test chamber, we can show you in person that your expansion joint cover will function as designed and will work under real-life conditions. Our test chamber is capable of testing the industry's largest joint covers.



With the new C/S iPad App, access to C/S Expansion Joint Cover info is a click away.



# And, only we can prove it works.

See a full-scale test in our exclusive test facility.

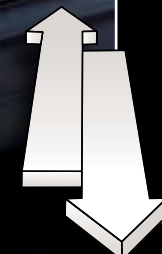

### Testing lateral shear

The chamber can test joint covers for lateral shear.

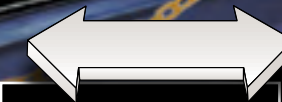

### Testing two-way movement

The chamber can cycle the joint cover for expansion and contraction.



### Testing multi-directional movement

C/S joint covers can be tested for four-way movement and vertical displacement.



# C/S pricing is all inclusive. Don't be fooled by competitors' low-ball prices!

C/S includes all of the following in our price:

- 1 Accurate quotes when you need them, how you need them
- 2 Complete shop drawings
- 3 A project manager to control the process from quote through installation
- 4 All code-compliant hardware required to mount covers properly to the building
- 5 Specialized equipment to help with installation
- 6 Multiple shipments to job site when specific material is needed for installation



Here's what the competitors may leave out!

- A complete quote that includes everything
- Shop drawings
- Design services
- Project coordinator
- Hardware
- Multiple shipments

**Remember to ask—what's included?**

# Selection Chart

Select Expansion Joint Covers are now available for purchase online. Go to [www.c-sgroup.com/buyejc](http://www.c-sgroup.com/buyejc)

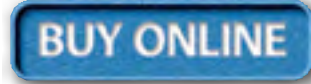

## Floor Covers

Joint sizes and movement dynamics dictate whether you require a standard or seismic expansion joint cover system. Before making a selection, there are other decisions you must make. The selection of the floor cover is often the most critical step in the specification

process since the performance of the floor cover has the greatest impact on the occupants of the building. The presence of rolling loads and the need for hygiene are major considerations in cover selection, while aesthetics in seismic covers is also a significant issue.

## Wall & Ceiling Covers

Having selected the floor cover, identifying a matching wall cover is a relatively simple task. However, when it comes to seismic covers, there are options driven by both functionality and aesthetics. Choose from covers that become detached from the wall to minimize damage or ones that are self-closing to minimize post-event maintenance. Many of our wall covers are designed to accept a range of surface materials to maximize concealment of the cover.

## Specialty Covers

Specialty covers, such as roof covers and vehicular joint systems, are available for most joint sizes and movement dynamics.

Cover Type	Flush Thinline Gasketed	Flush Twinline Dual Gasketed	Flush Seismic, Seismic Pan	Standard Allway Metal	Seismic Allway Metal	Seismic Corridor Cover	Flush Thinline Gasketed	Flush Twinline Dual Gasketed	Seismic Flush Twinline	Allway Metal	Exterior Wall	Roof	Parking & Stadiums
Appearance													
Joint Size	1" and 2"	2" to 4"	2" and up	1" to 4"	4" and up	12" to 36"	1" to 10"	2" and up	4" and up	1" to 4"	2" and up	2" and up	1" to 16"
Description	Minimum exposed surface, sealed dual durometer gasket installation	Minimum exposed surface, sealed dual durometer gasket installation, larger movement	Minimum exposed surface, optional sealed gasket installation, seismic movement	Robust applications, low maintenance	Robust applications, low maintenance, seismic movement	Corridors in base isolated structures with multi-directional movement	Minimum exposed surface, sealed gasket installation	Minimum exposed surface, sealed gasket installation, larger movement	Minimum exposed surface, optional sealed gasket installation, seismic movement	Robust applications, low maintenance, full movement range	Minimum exposed surface, sealed gasket installation, full movement range	Formed aluminum and EPDM bellows options, full movement range	Exterior, waterproof applications, full movement range
Finishes	Carpet, vinyl, ceramic tile, terrazzo, stone	Carpet, vinyl	Carpet, vinyl, terrazzo, stone	Concrete, carpet, vinyl	Concrete, pavers, carpet, vinyl, ceramic tile	Carpet, vinyl	Drywall, ceramic tile	Drywall, ceramic tile	Drywall, panel systems, metal cladding, stone	All finishes	All finishes	All roof finishes	Concrete, paver
Designed For	Hygienic, wheeled equipment	Hygienic, wheeled equipment	Hygienic, wheeled equipment, deep floor finish materials, also exterior	Industrial, heavy wheeled equipment	Industrial, heavy wheeled equipment, also exterior	Commercial and healthcare interiors	Hygienic, matches Thinline floor covers	Hygienic, matches Twinline floor covers	All commercial and healthcare interiors	Industrial, matches Allway floor covers	All exteriors, colorable	All roofs	Vehicular traffic, stadium seating bowls and concourse
% Movement +/-	50% of Joint Width	100% of Joint Width	100-200% of Joint Width	100-200% of Joint Width	100-200% of Joint Width	100-200% of Joint Width	50-200% of Joint Width	100-200% of Joint Width	100-200% of Joint Width	100-200% of Joint Width	100-200% of Joint Width	100-200% of Joint Width	50-200% of Joint Width
Page #	14-15	16-17	18-21	22-23	24-25	26-27	28-29	30-31	30-31	32-33	34-37	38-39	40-41
Matching Floor	N/A	N/A	N/A	N/A	N/A	N/A	14-15	16-17	18-21	22-23	N/A	N/A	N/A
Wall/Ceiling	28-29	30-31	30-31	32-33	30-31	26-27	N/A	N/A	N/A	N/A	N/A	N/A	N/A
Fire Barriers	Reflex Page 43	Reflex or Multiflex Page 43	Multiflex or FB-97 Page 43	Reflex Page 43	Multiflex Page 43	FB-97 Page 43	Reflex or Multiflex Page 43	Reflex or Multiflex Page 43	Multiflex or FB-97 Page 43	Reflex or Multiflex Page 43	Contact Factory	Contact Factory	Contact Factory
Cost Index	65	105	125	100	100	N/A	55	180	N/A	100	150	N/A	N/A



# Flush Thinline Floor Covers 1"-2"

Flush gasketed covers for small interior joints where minimal visual impact is preferred. Perfect for wheeled equipment. ADA-compliant.

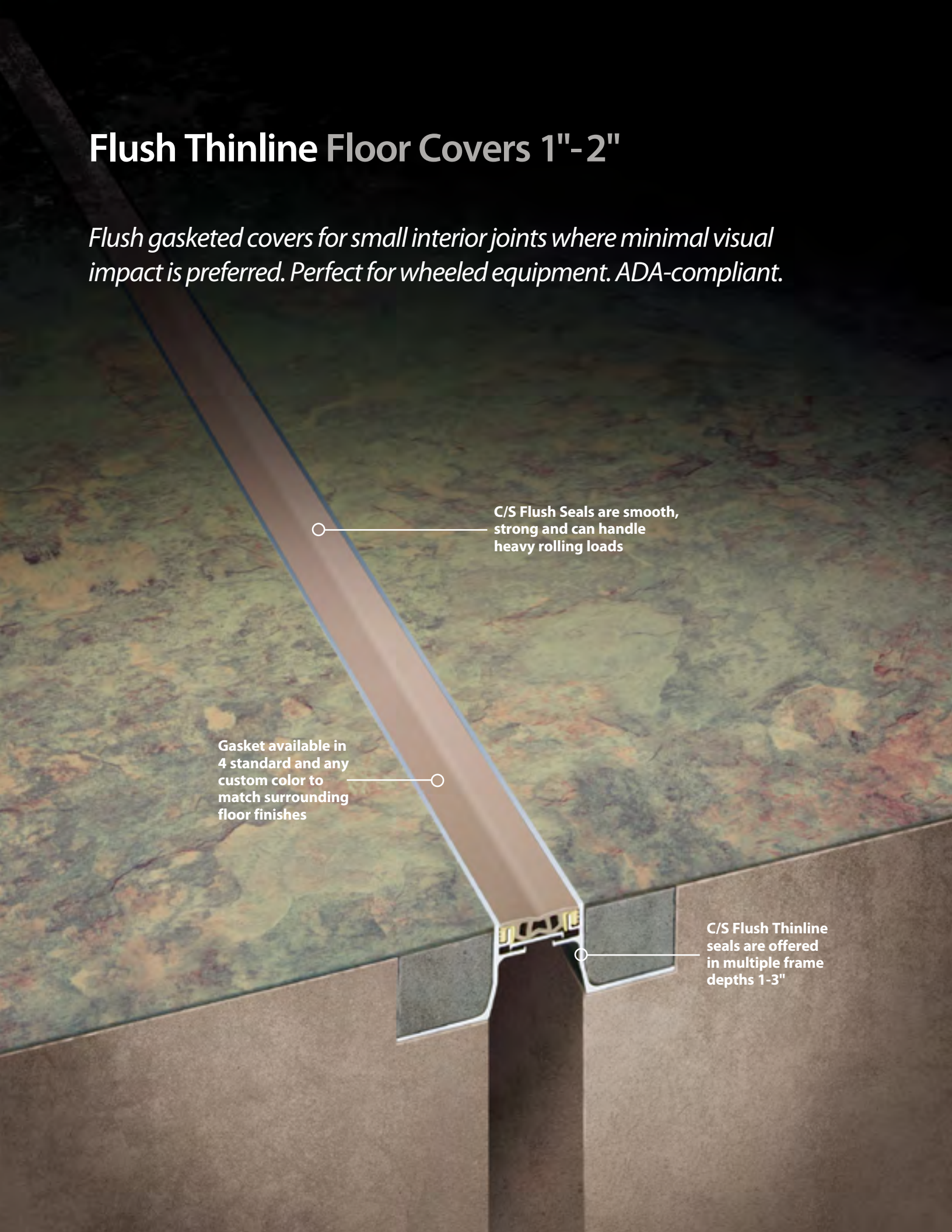

C/S Flush Seals are smooth, strong and can handle heavy rolling loads

Gasket available in 4 standard and any custom color to match surrounding floor finishes

C/S Flush Thinline seals are offered in multiple frame depths 1-3"

## FLOOR COVERS

GFT

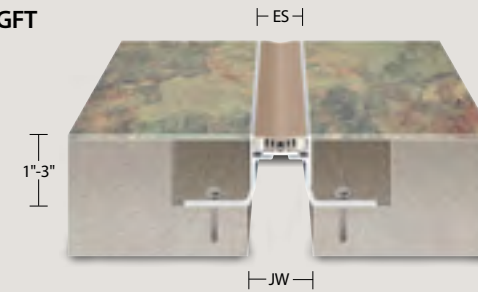

GFST

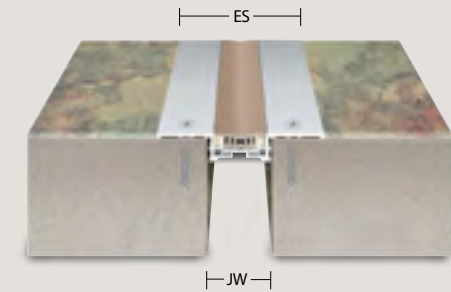

GFPS

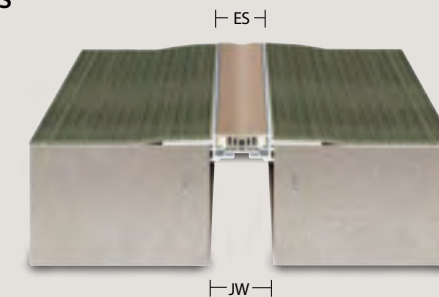

GFS

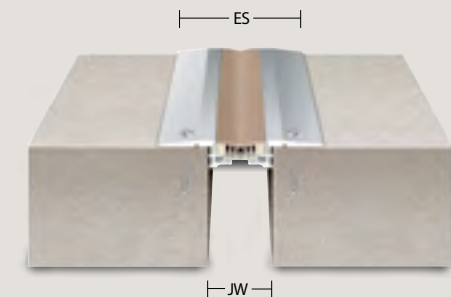

New heavy-duty design now standard.



Dual Durometer

- Harder materials for stronger more secure attachment to aluminum extrusions.
- Softer material used to allow for thermal movements.

## GASKET COLORS

Black

White

Gray

Greige

Note: Custom colors available. Call 800.233.8493.

## MODEL DATA

### FLOOR TO FLOOR COVERS

JOINT WIDTH	1"	2"	1"	2"	1"	2"	1"	2"
MINIMUM OPENING	0.75"	1.50"	0.75"	1.50"	0.75"	1.50"	0.75"	1.50"
MAXIMUM OPENING	1.25"	2.50"	1.25"	2.50"	1.25"	2.50"	1.25"	2.50"
EXPOSED SURFACE	1.25"	1.88"	1.18"	1.88"	4.31"	5.13"	4.31"	5.13"
SPECIFY MODEL	GFT 100	GFT 200	GFPS 100	GFPS 200	GFS 100	GFS 200	GFST 100	GFST 200

### FLOOR TO WALL COVERS

JOINT WIDTH	1"	2"	1"	2"	1"	2"	1"	2"
MINIMUM OPENING	0.75"	1.50"	0.75"	1.50"	0.75"	1.50"	0.75"	1.50"
MAXIMUM OPENING	1.25"	2.50"	1.25"	2.50"	1.25"	2.50"	1.25"	2.50"
EXPOSED SURFACE	1.13"	1.93"	1.09"	1.94"	2.69"	3.56"	2.66"	3.56"
SPECIFY MODEL	GFTW 100	GFTW 200	GFPSW 100	GFPSW 200	GFSW 100	GFSW 200	GFSTW 100	GFSTW 200

For odd and larger sized joints, call 800.233.8493 or visit [www.c-sgroup.com](http://www.c-sgroup.com)



# Flush Twinline Floor Covers 2"-4"

Dual gasketed flush covers with recessed cover plate offer added thermal movement yet blend unobtrusively with surrounding surfaces.

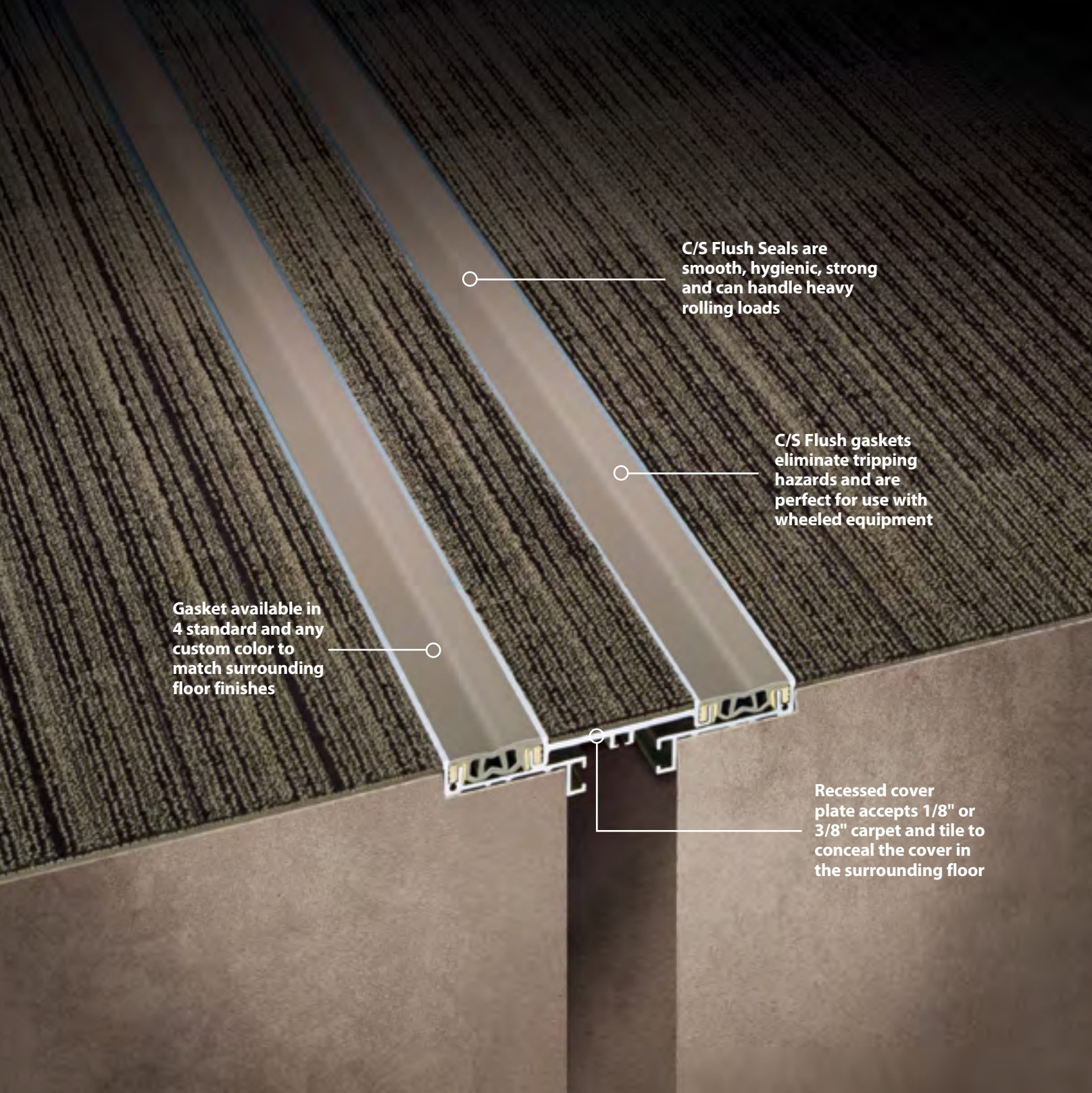

## FLOOR COVERS

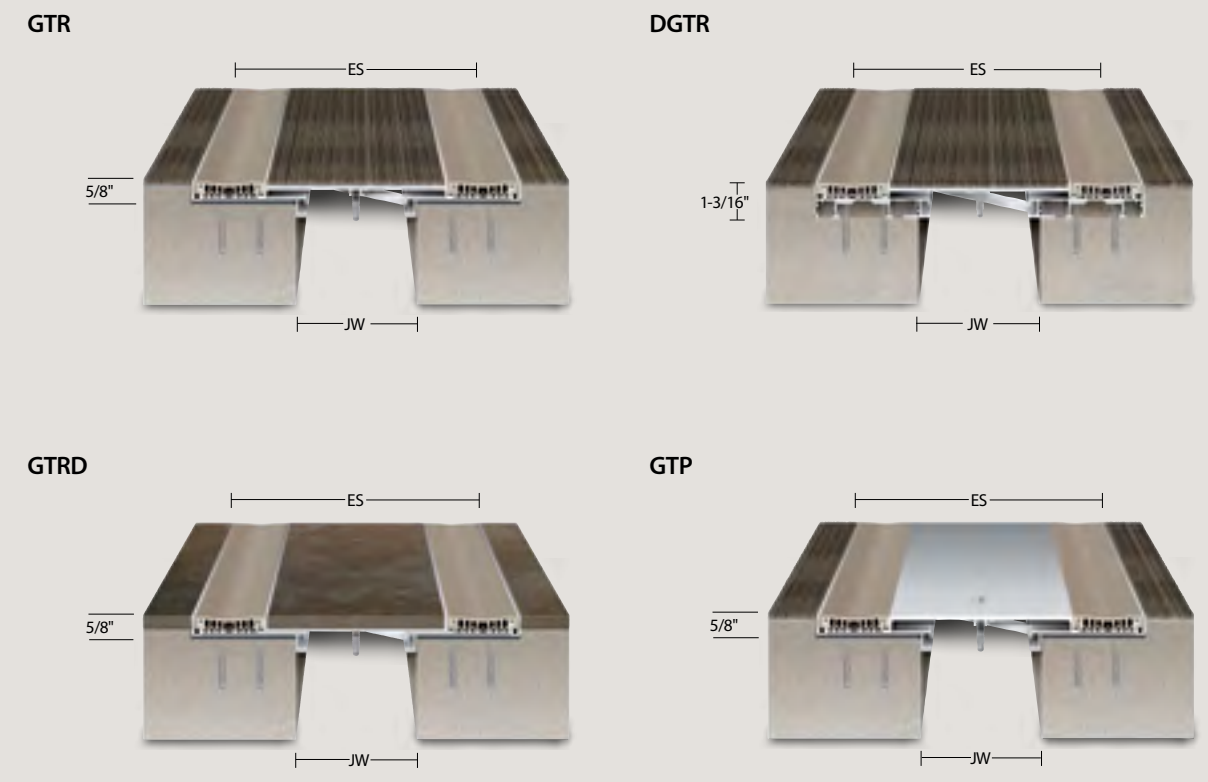

## GASKET COLORS

Black White Gray Greige  
 Note: Custom colors available. Call 800.233.8493.

## MODEL DATA

FLOOR TO FLOOR COVERS									
JOINT WIDTH	2"	3"	4"	2"	3"	4"	2"	3"	4"
MINIMUM OPENING	1.25"	1.25"	2.25"	1.25"	1.25"	1.25"	1.25"	1.25"	1.25"
MAXIMUM OPENING	3.75"	6.00"	6.25"	3.75"	6.00"	6.25"	3.75"	6.00"	6.25"
EXPOSED SURFACE	6.50"	10.00"	11.00"	6.50"	10.00"	11.00"	6.50"	10.00"	11.00"
SPECIFY MODEL	GTR 200	GTR 300	GTR 400	DGTR 200	DGTR 300	DGTR 400	GTP 200	GTP 300	GTP 400
FLOOR TO WALL COVERS									
JOINT WIDTH	2"	3"	4"	2"	3"	4"	2"	3"	4"
MINIMUM OPENING	1.00"	1.50"	2.50"	1.00"	1.50"	2.50"	1.00"	1.50"	2.50"
MAXIMUM OPENING	3.00"	4.50"	5.50"	3.00"	4.50"	5.50"	3.00"	4.50"	5.50"
EXPOSED SURFACE	4.25"	6.50"	7.50"	4.25"	6.50"	7.50"	4.25"	6.50"	7.50"
SPECIFY MODEL	GTRW 200	GTRW 300	GTRW 400	DGTRW 200	DGTRW 300	DGTRW 400	GTPW 200	GTPW 300	GTPW 400



# Flush Seismic Floor Covers 5"-Up

Our Flush Seismic covers concealed in surrounding floor finishes can accept carpet and vinyl flooring. Use where hygiene is critical.

Perfect for applications using carpet or vinyl floor covering up to 1/8"

Gasket available in 4 standard and any custom color to match surrounding floor finishes

Plate deflectors disengage gaskets during seismic activity to provide additional movement

5" to 16" joint covers to accommodate large seismic joints

## FLOOR COVERS

## FLOOR TO WALL COVERS

SGR

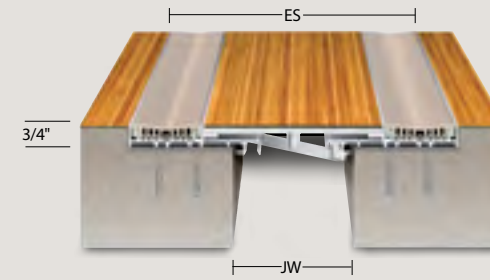

SGRW

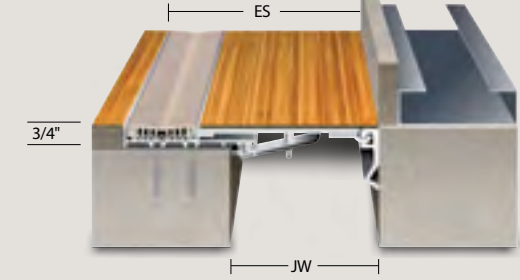

SGP

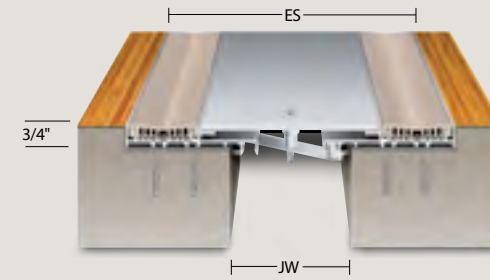

SGPW

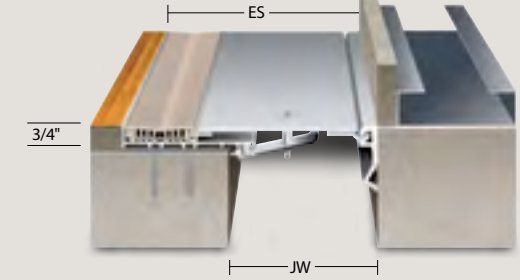

## GASKET COLORS

Black

White

Gray

Greige

Note: Custom colors available. Call 800.233.8493.

## MODEL DATA

### FLOOR TO FLOOR COVERS

JOINT WIDTH	5"	6"	7"	8"	9"	10"	11"	12"	13"	14"	15"	16"
MINIMUM OPENING	2.75"	2.75"	2.75"	2.75"	2.75"	2.75"	2.75"	2.75"	2.75"	2.75"	2.75"	2.75"
MAXIMUM OPENING	9.25"	9.25"	12.25"	13.25"	14.13"	16.25"	18.13"	18.38"	21.25"	22.25"	22.75"	25.25"
EXPOSED SURFACE	12.00"	13.00"	15.00"	16.00"	18.00"	19.00"	21.00"	22.00"	24.00"	25.00"	27.00"	28.00"
SPECIFY MODEL	SGR 500	SGR 600	SGR 700	SGR 800	SGR 900	SGR 1000	SGR 1100	SGR 1200	SGR 1300	SGR 1400	SGR 1500	SGR 1600

### FLOOR TO WALL COVERS

JOINT WIDTH	5"	6"	7"	8"	9"	10"	11"	12"	13"	14"	15"	16"
MINIMUM OPENING	3.56"	4.06"	4.94"	5.44"	5.94"	6.44"	6.94"	7.44"	7.94"	8.44"	8.94"	9.44"
MAXIMUM OPENING	6.56"	7.75"	9.69"	10.63"	11.56"	13.13"	14.63"	15.25"	17.13"	18.13"	18.75"	20.63"
EXPOSED SURFACE	8.50"	9.50"	11.00"	12.00"	13.50"	14.50"	16.00"	17.00"	18.50"	19.50"	21.00"	20.00"
SPECIFY MODEL	SGRW 500	SGRW 600	SGRW 700	SGRW 800	SGRW 900	SGRW 1000	SGRW 1100	SGRW 1200	SGRW 1300	SGRW 1400	SGRW 1500	SGRW 1600

SGR and SGP have same model data. SGRW and SGPW have same model data. For larger sized joints, call 800.233.8493 or visit [www.c-sgroup.com](http://www.c-sgroup.com)



# PAN Seismic Floor Covers 4"-Up

*Virtually invisible seismic floor covers for interior and exterior applications. Designed to accept a variety of floor finishes and handle multi-directional movement.*

Exclusive edge protection eliminates chipping of pavers

Can accept a variety of interior and exterior finishes and thicknesses

The thickness of the modular pan eliminates flooring deflection and cracking

Gravity-activated turnbar raises and lowers cover during seismic activity

For comprehensive information on these products, visit [www.c-sgroup.com/expansion-joint-covers](http://www.c-sgroup.com/expansion-joint-covers)

## FLOOR COVERS

SSR-200-400

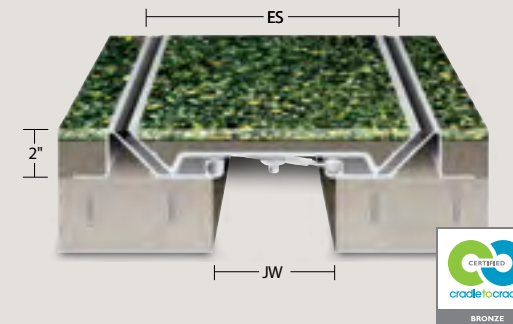

SSRH 200-400

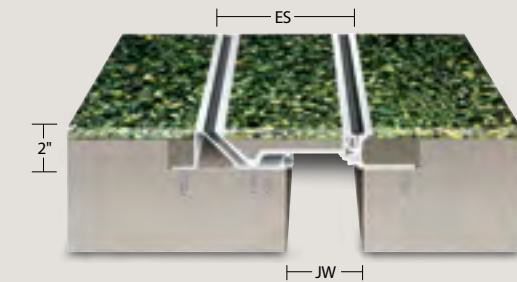

SSR-500+

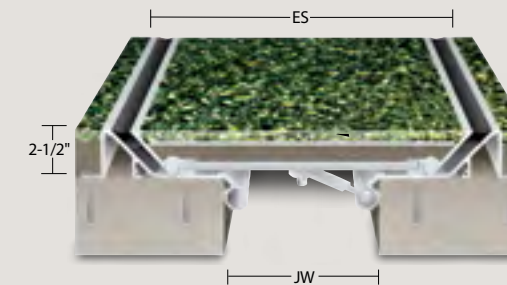

## MODEL DATA

### FLOOR TO FLOOR COVERS

JOINT WIDTH	2"	4"	6"	8"	10"	12"	14"	16"
MINIMUM OPENING	0.75"	1.50"	2.56"	4.00"	4.00"	4.00"	4.00"	4.00"
MAXIMUM OPENING	6.90"	8.50"	10.38"	13.13"	16.00"	18.88"	21.75"	24.75"
EXPOSED SURFACE	13.69"	13.69"	16.31"	20.75"	23.75"	26.75"	29.75"	32.75"
SPECIFY MODEL	SSR 200	SSR 400	SSR 600	SSR 800	SSR 1000	SSR 1200	SSR 1400	SSR 1600

### FLOOR TO WALL COVERS

JOINT WIDTH	2"	4"	6"	8"	10"	12"	14"	16"
MINIMUM OPENING	1.00"	1.75"	1.06"	1.06"	1.06"	1.06"	1.06"	1.06"
MAXIMUM OPENING	4.00"	6.00"	10.00"	13.00"	16.00"	19.00"	22.00"	25.00"
EXPOSED SURFACE	7.88"	8.88"	13.69"	16.69"	19.69"	22.69"	25.69"	28.69"
SPECIFY MODEL	SSRW 200	SSRW 400	SSRW 600	SSRW 800	SSRW 1000	SSRW 1200	SSRW 1400	SSRW 1600

For odd and larger sized joints, call 800.233.8493 or visit [www.c-sgroup.com](http://www.c-sgroup.com)



# Standard Allway Metal Floor Covers 1"-4"

The APF floor cover is designed to hold up in applications with heavy rolling load traffic. This cover works with most floor finishes and requires little maintenance.



Heavy duty cover perfect for heavy rolling loads

Gaskets eliminate noise and metal-to-metal contact

Free-floating aluminum center slides between cover frames to provide movement

A variety of frame heights available for different floor finishes

Excellent choice for Transit applications

## FLOOR COVERS

APF

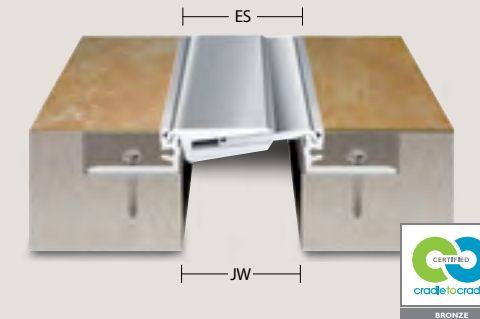

PC

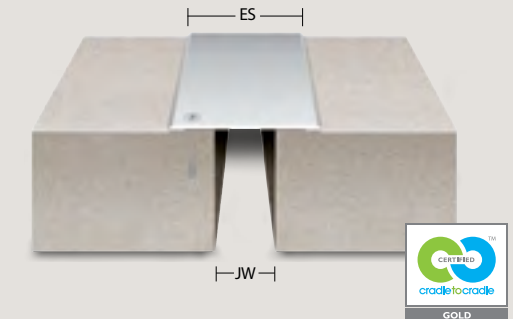

ALS

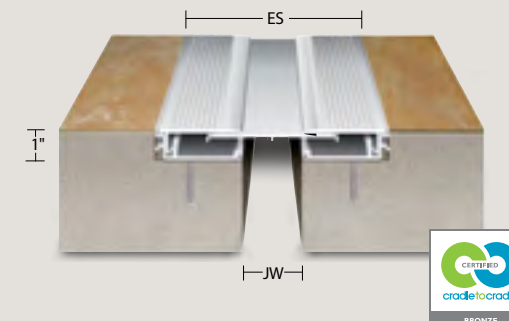

ALR

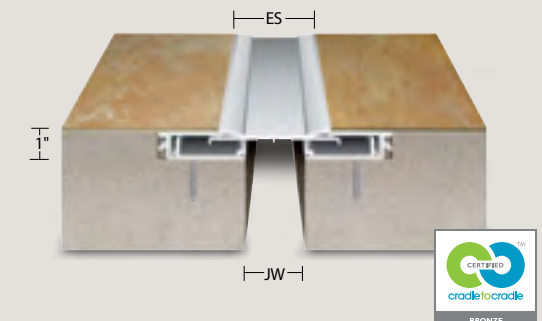

## MODEL DATA

### FLOOR TO FLOOR COVERS

JOINT WIDTH	1"	2"	3"	4"	2"	4"	2"	4"	2"	4"
MINIMUM OPENING	0.75"	1.63"	2.50"	3.25"	0.00"	0.88"	0.00"	0.88"	0.00"	0.00"
MAXIMUM OPENING	1.25"	2.38"	3.50"	4.75"	4.00"	7.00"	4.00"	7.00"	3.75"	6.75"
EXPOSED SURFACE	1.70"	3.30"	4.37"	5.28"	3.65"	6.44"	7.75"	11.75"	5.25"	8.25"
SPECIFY MODEL	APF 100	APF 200	APF 300	APF 400	ALR 200	ALR 400	ALS 200	ALS 400	PC 200	PC 400

### FLOOR TO WALL COVERS

JOINT WIDTH	1"	2"	3"	4"	2"	4"	2"	4"	2"	4"
MINIMUM OPENING	0.75"	1.63"	2.50"	3.25"	1.00"	2.44"	1.00"	2.44"	0.00"	0.00"
MAXIMUM OPENING	1.25"	2.38"	3.50"	4.75"	3.00"	5.50"	3.00"	5.50"	3.75"	6.75"
EXPOSED SURFACE	1.70"	3.30"	4.37"	5.28"	2.81"	5.19"	4.88"	7.88"	3.75"	6.75"
SPECIFY MODEL	APFW 100	APFW 200	APFW 300	APFW 400	ALRW 200	ALRW 400	ALSW 200	ALSW 400	PCW 200	PCW 400

For odd and larger sized joints, call 800.233.8493 or visit [www.c-sgroup.com](http://www.c-sgroup.com)

Note: All joint systems on this page are available for 1"-4" joints. Contact factory if required size is not listed.



# Seismic Allway Metal Floor Covers 4"- Up

Interior or exterior seismic metal covers are designed to provide four-way movement. Covers remain flush during typical thermal movement. A heavy duty model is available for rolling loads.

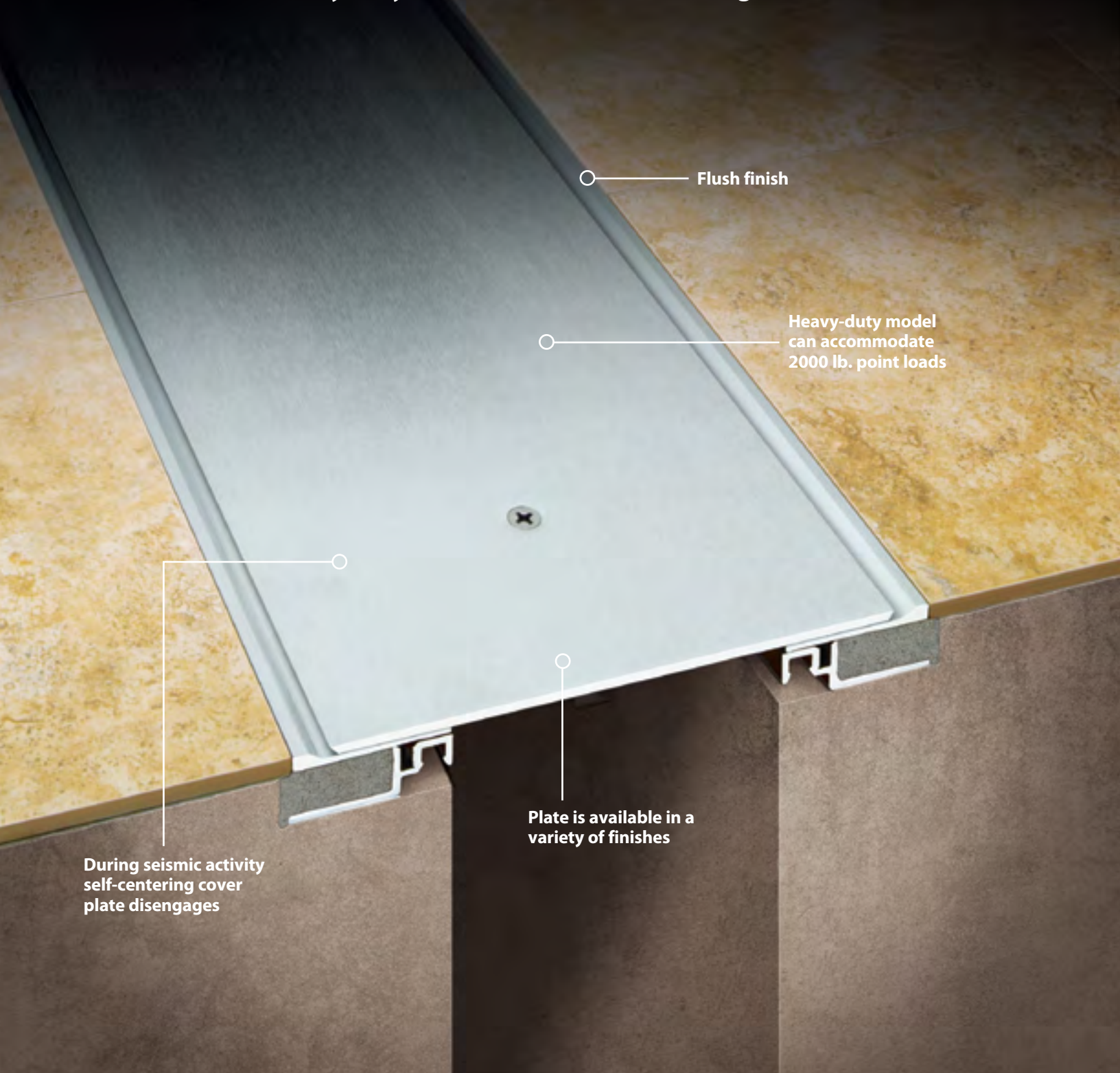

## FLOOR COVERS

SJPF

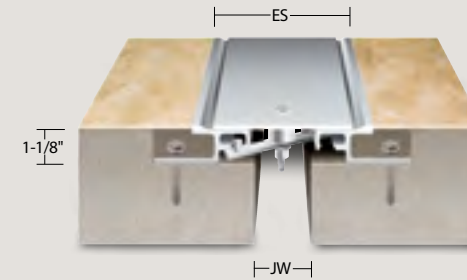

SJP

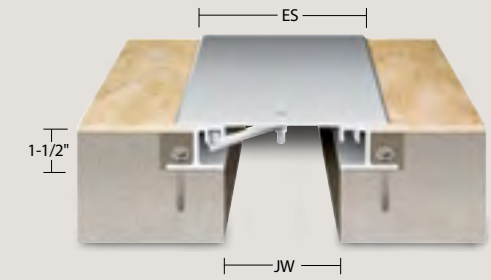

SJPFM

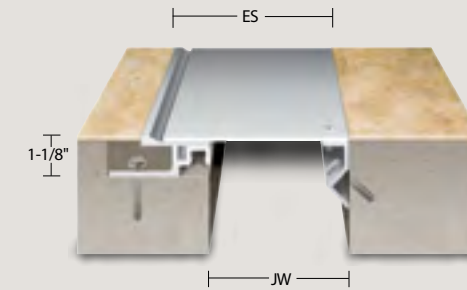

SJHD

Heavy Duty 2,000 lb. Point Load

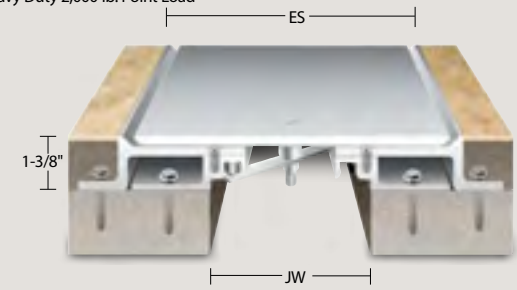

## MODEL DATA

### FLOOR TO FLOOR COVERS

JOINT WIDTH	4"	6"	8"	2"	4"	6"	2"	4"	6"	8"	10"	12"	14"	16"
MINIMUM OPENING	2.75"	2.75"	2.75"	1.00"	1.00"	1.00"	1.00"	1.00"	1.00"	1.00"	1.00"	1.00"	1.00"	1.00"
MAXIMUM OPENING	6.36"	9.25"	13.50"	4.00"	6.50"	9.88"	4.50"	7.50"	11.13"	14.25"	16.75"	21.00"	23.75"	24.25"
EXPOSED SURFACE	8.75"	11.75"	14.75"	5.50"	8.00"	11.50"	4.50"	7.50"	11.88"	15.00"	17.94"	21.00"	23.88"	27.00"
SPECIFY MODEL	SJ-HD 400	SJ-HD 600	SJ-HD 800	SJPF 200	SJPF 400	SJPF 600	SJP 200	SJP 400	SJP 600	SJP 800	SJP 1000	SJP 1200	SJP 1400	SJP 1600

### FLOOR TO WALL COVERS

JOINT WIDTH	4"	6"	8"	2"	4"	6"	2"	4"	6"	8"	10"	12"	14"	16"
MINIMUM OPENING	1.00"	1.00"	5.38"	0.00"	0.00"	0.00"	0.00"	0.00"	0.00"	4.50"	5.50"	6.50"	7.50"	8.50"
MAXIMUM OPENING	6.32"	8.82"	11.04"	3.00"	5.25"	7.94"	3.25"	5.75"	8.50"	10.00"	13.31"	16.50"	18.75"	20.00"
EXPOSED SURFACE	6.38"	8.88"	11.38"	3.75"	6.00"	8.75"	3.25"	5.75"	8.94"	11.50"	14.00"	16.50"	18.94"	21.50"
SPECIFY MODEL	SJW-HD 400	SJW-HD 600	SJW-HD 800	SJPFW 200	SJPFW 400	SJPFW 600	SJPW 200	SJPW 400	SJPW 600	SJPW 800	SJPW 1000	SJPW 1200	SJPW 1400	SJPW 1600

For odd and larger sized joints, call 800.233.8493 or visit [www.c-sgroup.com](http://www.c-sgroup.com)



# Seismic Corridor Covers for Base Isolated Structures

*This system allows full access between base isolated and fixed structures. It is perfect where egress is necessary during an earthquake.*



de Young Museum, CA

For comprehensive information on these products, visit [www.c-sgroup.com/expansion-joint-covers](http://www.c-sgroup.com/expansion-joint-covers)

Because base isolated structures are free to move in any horizontal direction, they create distinct challenges for the design of the seismic joint covers. The C/S solution for base isolated structures is an integrated assembly approach with floor, wall and ceiling covers connected and moving in unison. This Gyrometric System, or “cab assembly,” provides full movement of up to 200% in any horizontal direction. The floor cover may be used independently of the wall and ceiling covers for lineal applications where lateral shear is a problem (specify model XYZ).

## HOW THE GYROMETRIC COVER WORKS

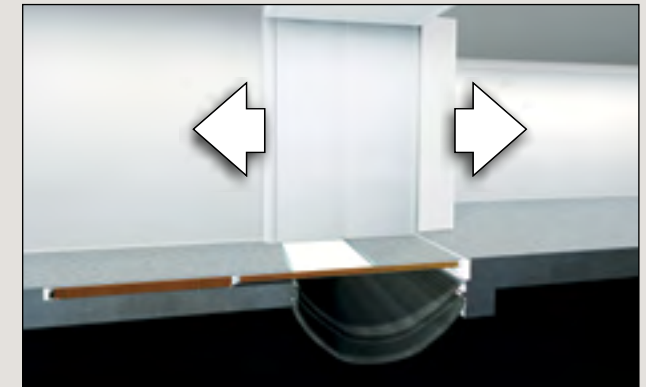

**Full Open (During Tension)** During an event, the cab slides out fully in the expansion (or tension) mode.

## COVER DETAILS

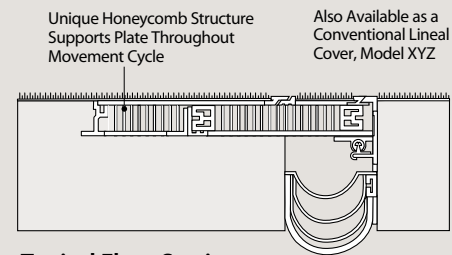

Typical Floor Section

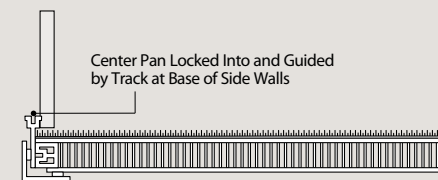

Floor/Wall Section

- OSHPD approved designs
- Complies with ASTM E1399
- Complimentary pre-construction design assistance
- Fire rating available; compliant with UL 2079
- Wide range of custom finishes available
- Virtually any joint size/movement capability can be accommodated.

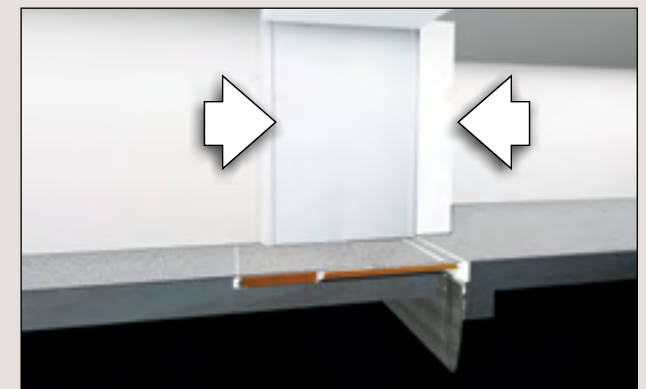

**Full Closed (During Compression)** During an event, the cab slides fully into the adjoining structure in the contraction (or compression) mode.



**Lateral Shear** The cab is attached to the fixed structure by means of a friction-free sliding track assembly to allow full lateral shear between buildings.



# Flush Thinline Wall and Ceiling Covers 1"-10"

These flush gasketed wall and ceiling covers are designed to align with our flush gasketed floor covers. These covers are suitable for most wall and ceiling finishes and are completely unobtrusive.

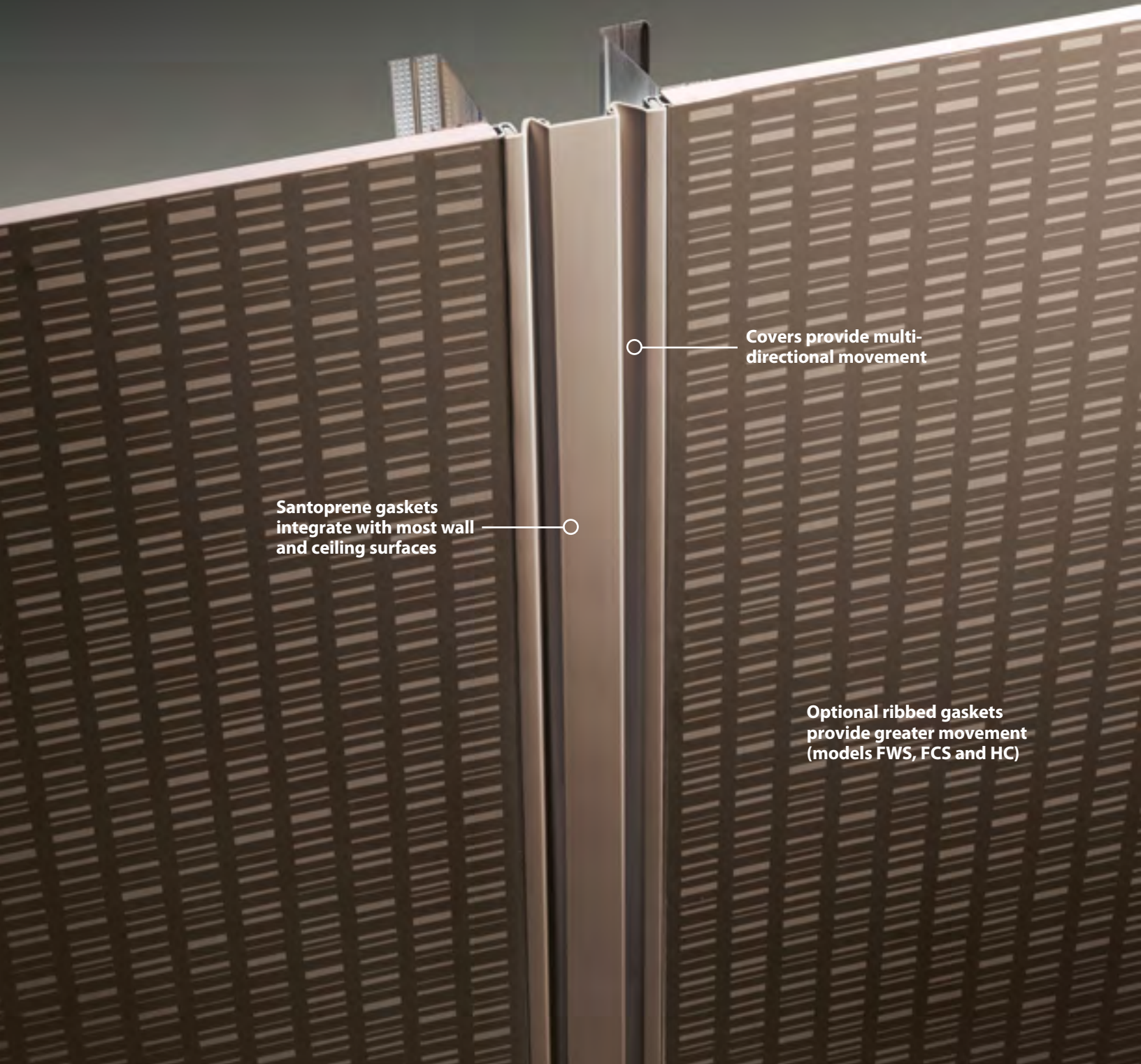

Santoprene gaskets integrate with most wall and ceiling surfaces

Covers provide multi-directional movement

Optional ribbed gaskets provide greater movement (models FWS, FCS and HC)

## WALL COVERS      CEILING COVERS

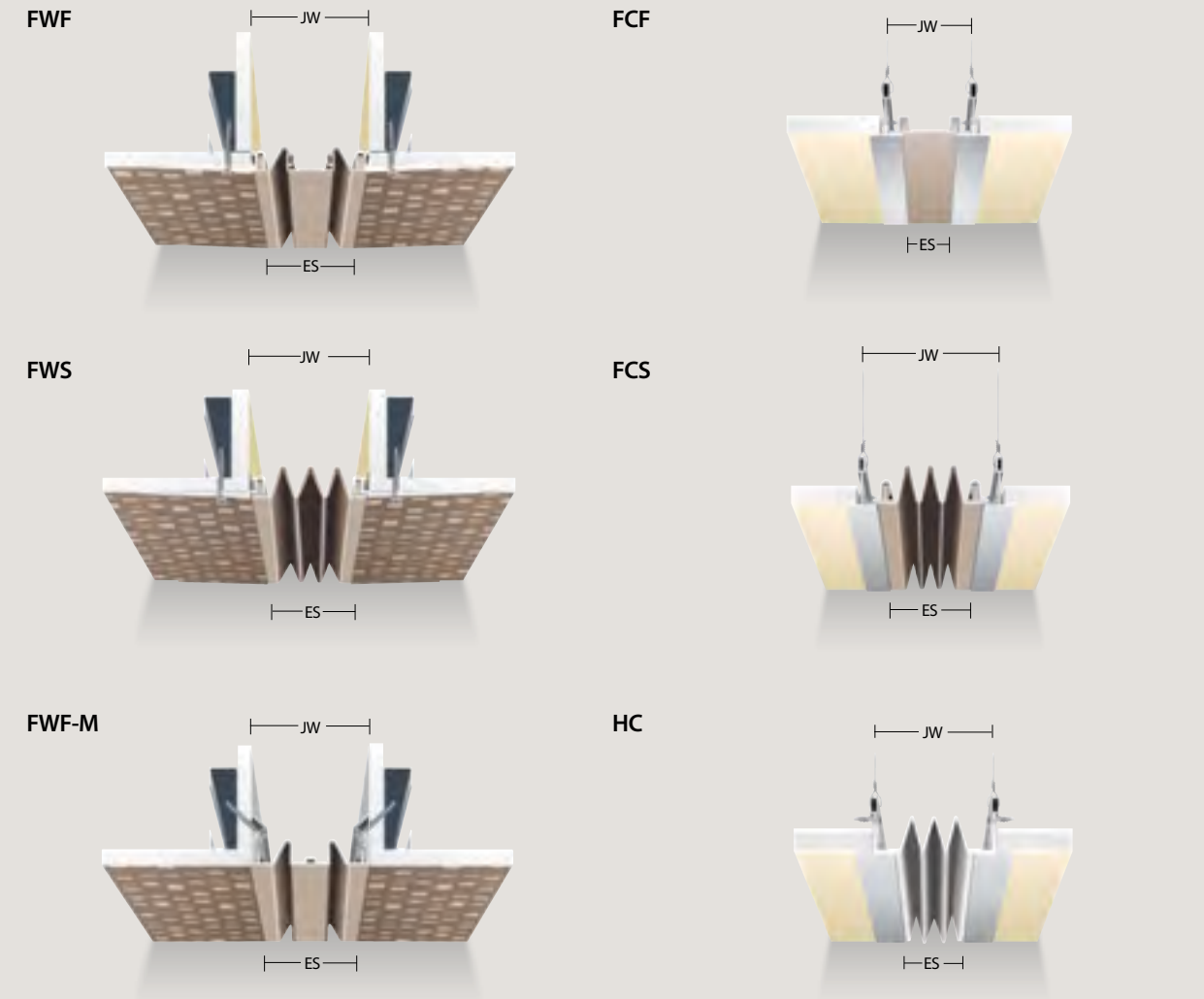

**GASKET COLORS**    Black    White    Gray    Greige

Note: Custom colors available. Call 800.233.8493.

### MODEL DATA

WALL TO WALL COVERS								CEILING COVERS							
JOINT WIDTH	1"	2"	3"	4"	2"	3"	4"	1"	2"	3"	4"	2"	3"	4"	
MINIMUM OPENING	0.60"	0.60"	1.25"	1.25"	1.25"	1.25"	1.25"	0.60"	0.60"	1.25"	1.25"	1.25"	1.25"	1.25"	
MAXIMUM OPENING	1.25"	2.50"	4.50"	6.00"	4.00"	6.00"	8.00"	1.25"	2.50"	4.50"	6.00"	4.00"	6.00"	8.00"	
EXPOSED SURFACE	1.06"	2.06"	3.00"	4.00"	2.00"	3.00"	4.00"	0.81"	1.63"	3.00"	4.00"	2.00"	3.00"	4.00"	
SPECIFY MODEL	FWF 100	FWF 200	FWF 300	FWF 400	FWS 200	FWS 300	FWS 400	FCF 100	FCF 200	FCF 300	FCF 400	FCS 200	FCS 300	FCS 400	
CORNER WALL COVERS								CORNER CEILING COVERS							
JOINT WIDTH	1"	2"	3"	4"	2"	3"	4"	1"	2"	3"	4"	2"	3"	4"	
MINIMUM OPENING	0.75"	.75"	1.25"	1.25"	1.25"	1.25"	1.25"	0.75"	0.75"	1.25"	1.25"	1.25"	1.25"	1.25"	
MAXIMUM OPENING	1.25"	2.50"	4.50"	6.00"	4.00"	6.00"	8.00"	1.25"	2.50"	4.50"	6.00"	4.00"	6.00"	8.00"	
EXPOSED SURFACE	1.06"	2.06"	3.00"	4.00"	2.00"	3.00"	4.00"	1.00"	1.75"	3.00"	4.00"	2.00"	3.00"	4.00"	
SPECIFY MODEL	FWFC 100	FWFC 200	FWFC 300	FWFC 400	FWSC 200	FWSC 300	FWSC 400	FCFC 100	FCFC 200	FCFC 300	FCFC 400	FCSC 200	FCSC 300	FCSC 400	

For odd and larger sized joints, call 800.233.8493 or visit [www.c-sgroup.com](http://www.c-sgroup.com)



# Flush Twinline Wall and Ceiling Covers 2"-Up

The LAF Flush Twinline Wall Cover utilizes a lightweight, free-floating, honeycomb panel, which is designed to prevent damage to surrounding walls.



## WALL COVERS

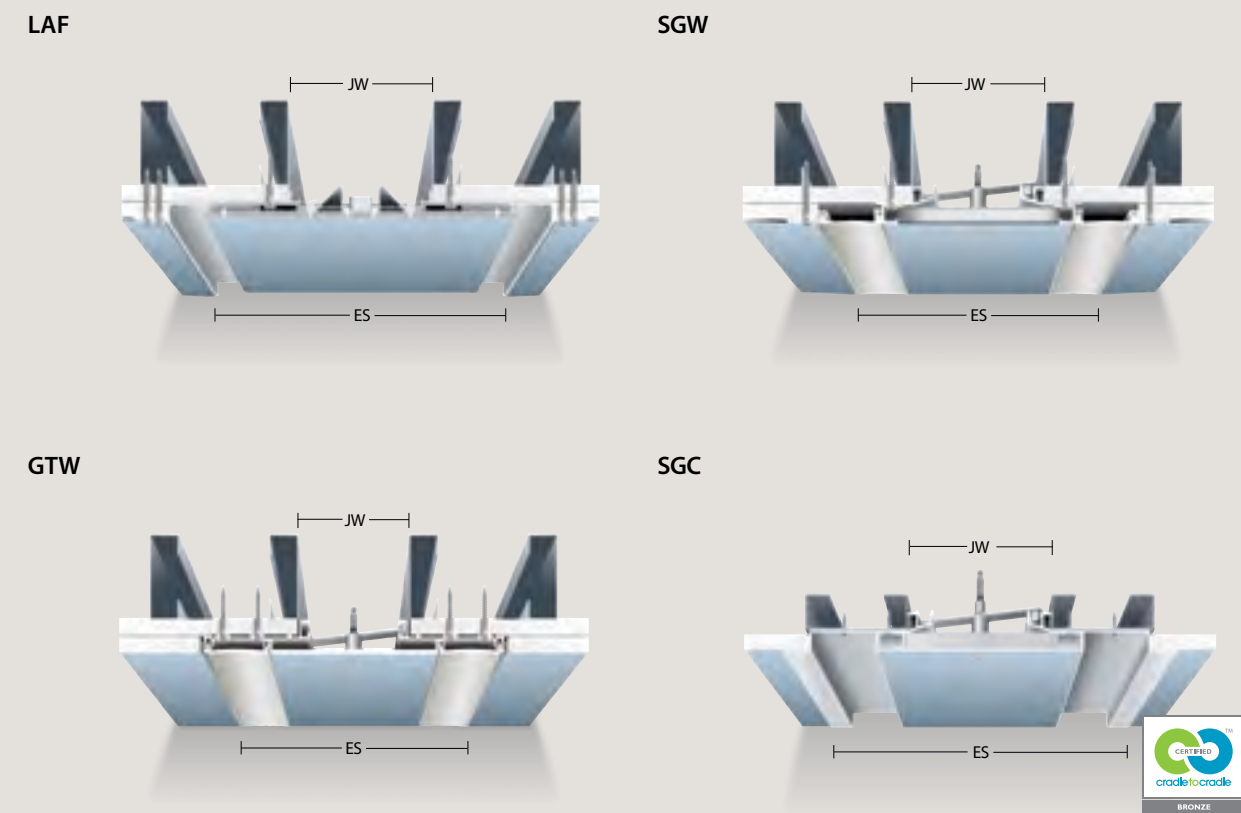

## GASKET COLORS

Black White Gray Greige  
 Note: Custom colors available. Call 800.233.8493.

## MODEL DATA

WALL TO WALL COVERS															
JOINT WIDTH	2"	4"	6"	8"	10"	12"	14"	16"	4"	6"	8"	10"	12"	14"	16"
MINIMUM OPENING	1.25"	1.25"	2.75"	2.75"	2.75"	2.75"	2.75"	2.75"	1.00"	1.00"	1.00"	1.00"	1.00"	1.00"	1.00"
MAXIMUM OPENING	3.75"	6.25"	9.25"	12.75"	15.75"	18.75"	21.75"	24.75"	8.00"	12.00"	16.00"	20.00"	24.00"	28.00"	32.00"
EXPOSED SURFACE	6.50"	11.00"	13.00"	16.00"	19.00"	22.00"	25.00"	28.00"	14.31"	16.31"	18.31"	20.31"	22.31"	24.31"	26.31"
SPECIFY MODEL	GTW 200	GTW 400	SGW 600	SGW 800	SGW 1000	SGW 1200	SGW 1400	SGW 1600	LAF 400	LAF 600	LAF 800	LAF 1000	LAF 1200	LAF 1400	LAF 1600
CORNER WALL COVERS															
JOINT WIDTH	2"	4"	6"	8"	10"	12"	14"	16"	4"	6"	8"	10"	12"	14"	16"
MINIMUM OPENING	1.00"	2.50"	4.25"	5.50"	6.50"	7.50"	8.50"	9.50"	2.50"	2.50"	2.50"	2.50"	2.50"	2.50"	2.50"
MAXIMUM OPENING	3.00"	5.50"	7.50"	10.25"	12.75"	15.25"	17.75"	20.25"	8.00"	12.00"	16.00"	20.00"	24.00"	28.00"	32.00"
EXPOSED SURFACE	4.25"	7.50"	9.50"	12.00"	14.50"	17.00"	19.50"	22.00"	9.13"	11.13"	13.13"	15.13"	17.13"	19.13"	21.13"
SPECIFY MODEL	GTWC 200	GTWC 400	SGWC 600	SGWC 800	SGWC 1000	SGWC 1200	SGWC 1400	SGWC 1600	LAFC 400	LAFC 600	LAFC 800	LAFC 1000	LAFC 1200	LAFC 1400	LAFC 1600

For odd and larger sized joints, call 800.233.8493 or visit [www.c-sgroup.com](http://www.c-sgroup.com)



# Allway Metal Wall and Ceiling Covers 1"-4"

Metal covers for interior applications are designed to align with our Allway Floor covers. Supplied in standard clear anodized finish; Kynar® paint colors are also available.

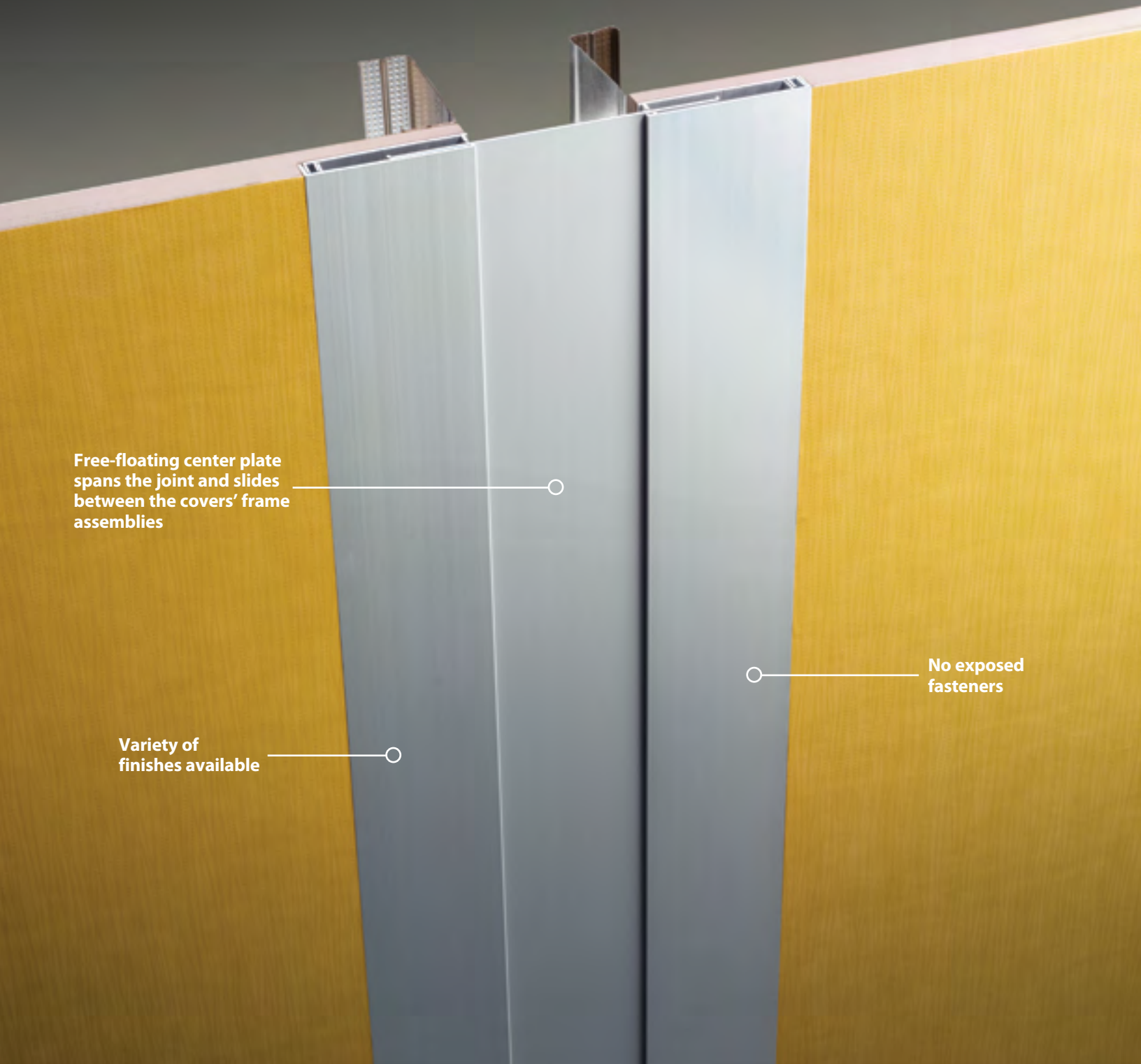

Free-floating center plate spans the joint and slides between the covers' frame assemblies

No exposed fasteners

Variety of finishes available

## WALL COVERS

AFW

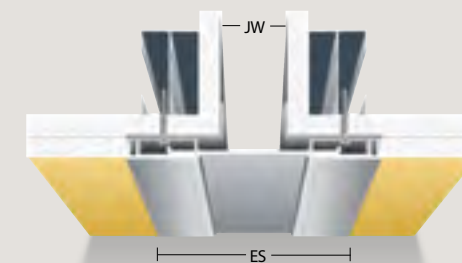

ASM

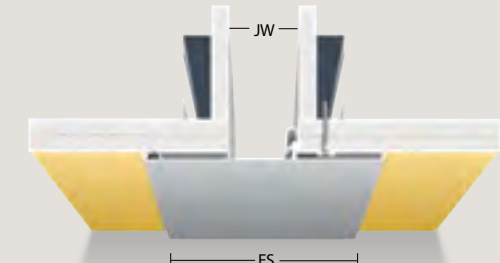

SFW

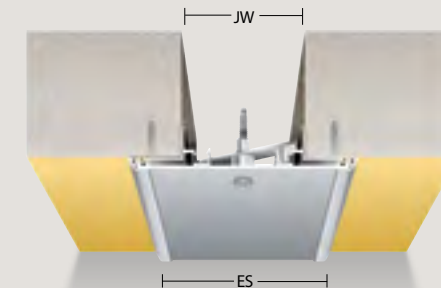

SFC

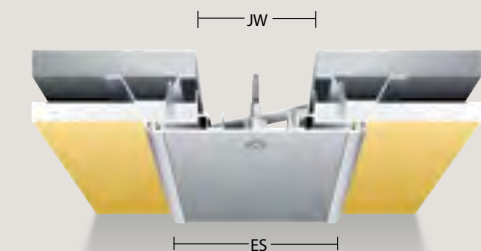

## MODEL DATA

WALL TO WALL COVERS								SFW MOVEMENT DATA					
JOINT WIDTH	1"	2"	3"	4"	1"	2"	3"	4"	4"	8"	12"	16"	
MINIMUM OPENING	0.25"	0.38"	0.00"	1.00"	0.38"	0.38"	0.38"	0.38"	2.88"	2.88"	2.88"	2.88"	
MAXIMUM OPENING	1.88"	3.50"	6.38"	7.38"	1.50"	3.00"	6.00"	6.00"	7.25"	14.13"	18.50"	25.88"	
EXPOSED SURFACE	5.00"	7.75"	10.75"	11.75"	3.13"	4.63"	7.63"	7.63"	7.50"	15.00"	21.00"	27.00"	
SPECIFY MODEL	AFW 100	AFW 200	AFW 300	AFW 400	ASM 100	ASM 200	ASM 300	ASM 400	SFW 400	SFW 800	SFW 1200	SFW 1600	

CORNER WALL COVERS								SCW MOVEMENT DATA					
JOINT WIDTH	1"	2"	3"	4"	1"	2"	3"	4"	4"	8"	12"	16"	
MINIMUM OPENING	0.63"	1.19"	1.50"	2.50"	0.50"	0.50"	0.50"	0.50"	0.00"	5.44"	7.44"	9.44"	
MAXIMUM OPENING	1.44"	2.75"	4.69"	5.69"	1.50"	3.00"	6.00"	6.00"	5.50"	11.06"	15.25"	19.44"	
EXPOSED SURFACE	2.38"	4.25"	6.25"	7.25"	1.88"	3.38"	6.38"	6.38"	5.75"	11.50"	16.25"	21.50"	
SPECIFY MODEL	AFWC 100	AFWC 200	AFWC 300	AFWC 400	ASMC 100	ASMC 200	ASMC 300	ASMC 400	SCW 400	SCW 800	SCW 1200	SCW 1600	

For odd and larger sized joints, call 800.233.8493 or visit [www.c-sgroup.com](http://www.c-sgroup.com).

Note: additional wall and ceiling cover models SFW and SFC available, go to [www.c-sgroup.com](http://www.c-sgroup.com).



# Exterior Wall Flexible Seals 2"-Up

C/S Exterior Flexible Seals are designed for vertical applications where weather protection is critical. The seals provide multi-directional movement and are available for joints up to 36" wide.

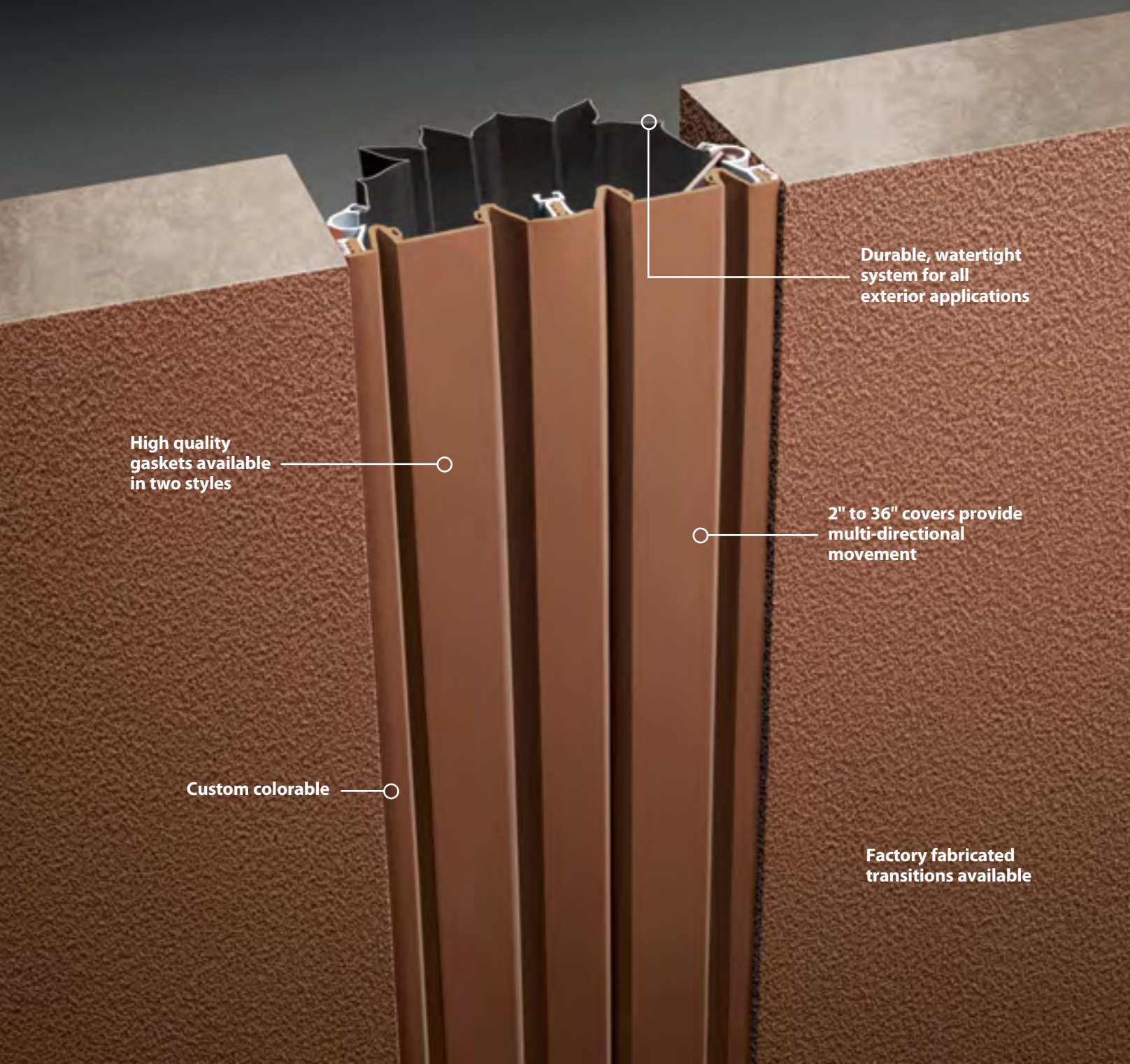

Durable, watertight system for all exterior applications

High quality gaskets available in two styles

2" to 36" covers provide multi-directional movement

Custom colorable

Factory fabricated transitions available

## WALL COVERS

SF-300

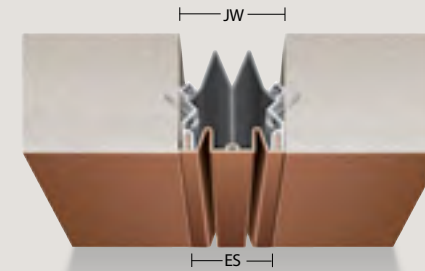

SF-800

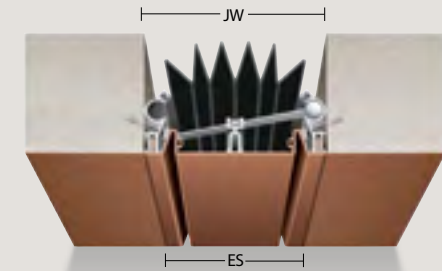

SF-1200

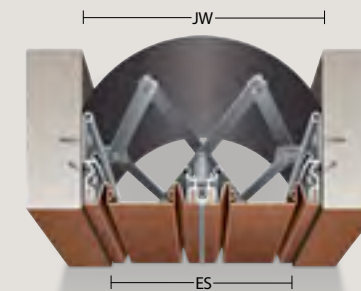

VF

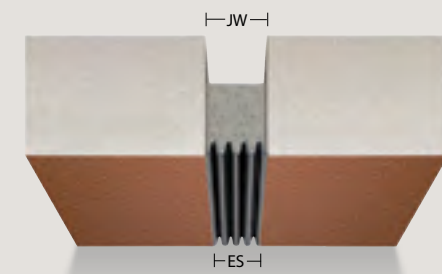

### MODEL VF COLORS

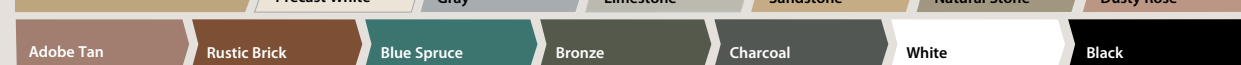

### GASKET COLORS



Note: Custom colors available. Call 800.233.8493.

## MODEL DATA

### EXTERIOR WALL COVERS

JOINT WIDTH	2"	3"	4"	5"	6"	7"	8"	9"	10"	12"	14"	16"	1.0"	2.0"	3.0"	4.0"	6.0"	8.0"
MINIMUM OPENING	1.25"	1.25"	1.25"	1.25"	1.75"	2.50"	2.50"	2.50"	2.50"	6.00"	6.00"	6.00"	0.50"	1.00"	1.50"	2.00"	3.00"	4.00"
MAXIMUM OPENING	3.00"	4.50"	6.00"	7.50"	9.00"	10.50"	12.00"	13.50"	15.00"	18.00"	21.00"	24.00"	1.50"	3.00"	4.50"	6.00"	9.00"	12.00"
EXPOSED SURFACE	2.00"	3.00"	4.00"	5.00"	6.00"	7.00"	8.00"	9.00"	10.00"	12.00"	14.00"	16.00"	1.00"	2.00"	3.00"	4.00"	6.00"	8.00"
SPECIFY MODEL	SF 200	SF 300	SF 400	SF 500	SF 600	SF 700	SF 800	SF 900	SF 1000	SF 1200	SF 1400	SF 1600	VF 100	VF 200	VF 300	VF 400	VF 600	VF 800

### EXTERIOR WALL COVERS

JOINT WIDTH	4"	5"	6"	7"	8"	9"	10"	11"	12"	13"	14"	15"	16"
MINIMUM OPENING	1.25"	1.75"	1.75"	2.50"	2.50"	2.50"	2.50"	6.00"	6.00"	6.00"	6.00"	6.00"	6.00"
MAXIMUM OPENING	8.00"	10.00"	12.00"	14.00"	16.00"	18.00"	20.00"	22.00"	24.00"	26.00"	28.00"	30.00"	32.00"
EXPOSED SURFACE	4.00"	5.00"	6.00"	7.00"	8.00"	9.00"	10.00"	11.00"	12.00"	13.00"	14.00"	15.00"	16.00"
SPECIFY MODEL	SC 400	SC 500	SC 600	SC 700	SC 800	SC 900	SC 1000	SC 1100	SC 1200	SC 1300	SC 1400	SC 1500	SC 1600

For odd and larger sized joints, call 800.233.8493 or visit [www.c-sgroup.com](http://www.c-sgroup.com)



# Seismic Exterior Wall Covers 8"-Up

XLS exterior covers are virtually invisible on seismic applications. Perfect for concealment in curtain wall finishes (supplied by others) up to 9/16" thick. Covers release from one side for full seismic movement and return to closed position.

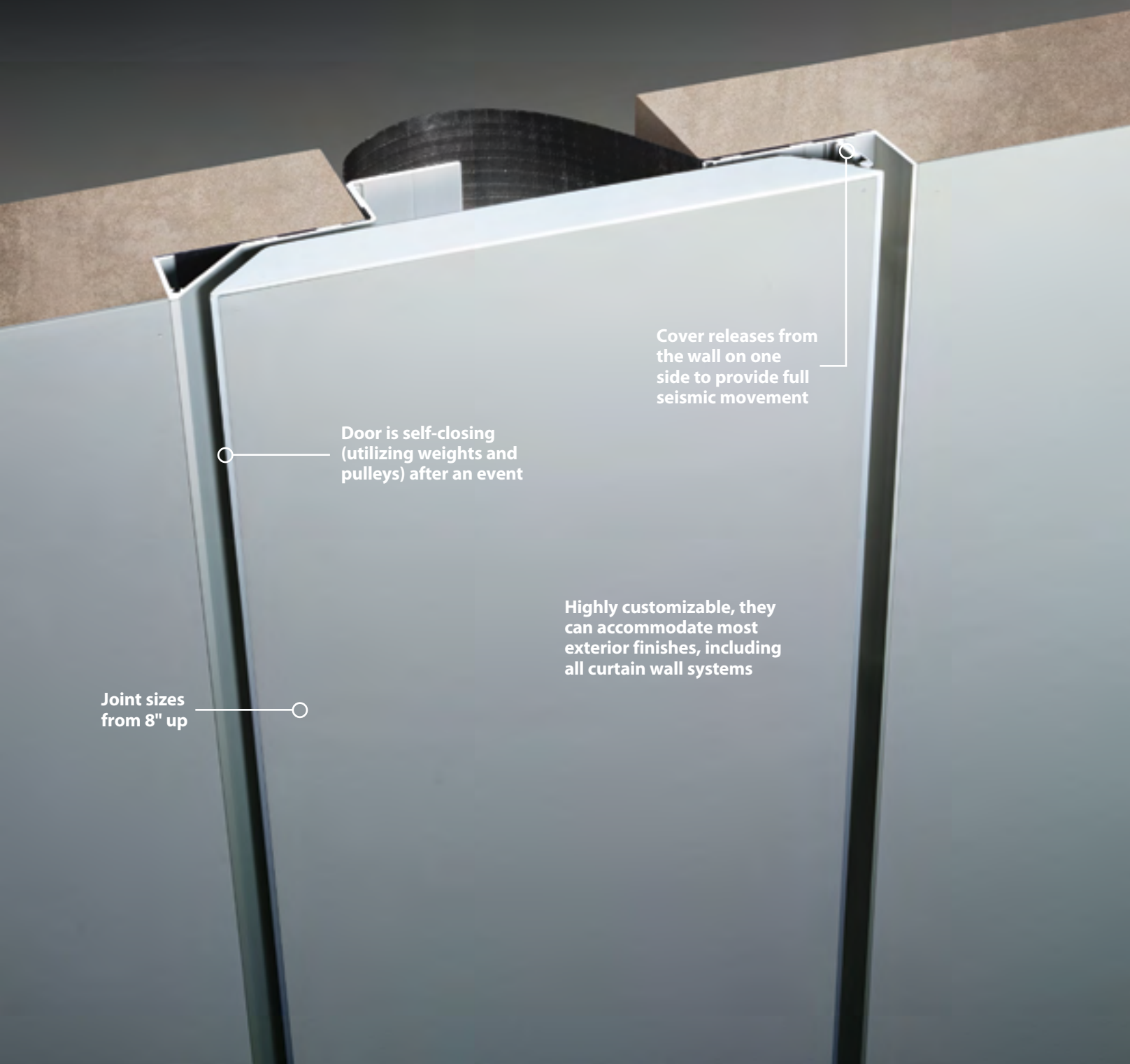

Cover releases from the wall on one side to provide full seismic movement

Door is self-closing (utilizing weights and pulleys) after an event

Highly customizable, they can accommodate most exterior finishes, including all curtain wall systems

Joint sizes from 8" up

## WALL COVERS

### XLS

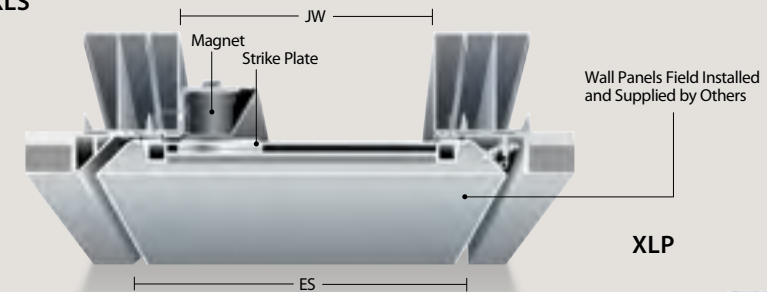

### XLS Contracted

Counterweight Cord (magnet not shown)

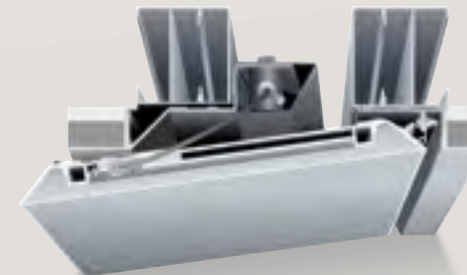

### XLS Expanded

Magnet (counterweight cord not shown)



### XLP

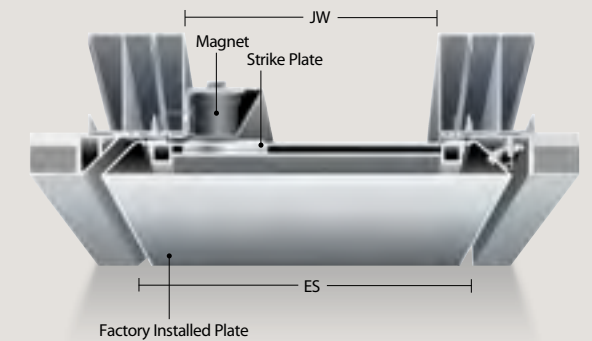

### ESW

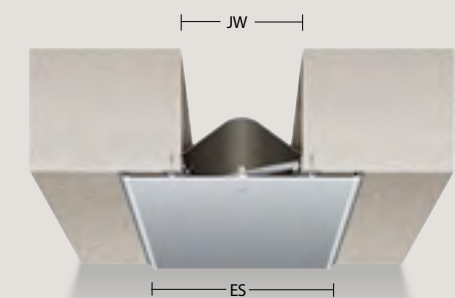

## MODEL DATA

### EXTERIOR WALL TO WALL COVERS

JOINT WIDTH	8"	10"	12"	14"	16"	4"	8"	12"	16"
MINIMUM OPENING	4.00"	4.00"	4.00"	4.00"	4.00"	2.50"	2.50"	2.50"	2.50"
MAXIMUM OPENING	16.00"	20.00"	24.00"	28.00"	32.00"	6.00"	13.00"	19.00"	25.00"
EXPOSED SURFACE	17.31"	19.31"	21.31"	23.31"	25.31"	12.00"	18.00"	24.00"	30.00"
SPECIFY MODEL	XLS/XLP 800	XLS/XLP 1000	XLS/XLP 1200	XLS/XLP 1400	XLS/XLP 1600	ESW 400	ESW 800	ESW 1200	ESW 1600

### EXTERIOR CORNER WALL COVERS

JOINT WIDTH	8"	10"	12"	14"	16"	4"	8"	12"	16"
MINIMUM OPENING	4.00"	4.00"	4.00"	4.00"	4.00"	3.25"	5.25"	7.25"	8.75"
MAXIMUM OPENING	16.00"	20.00"	24.00"	28.00"	32.00"	6.50"	10.50"	15.50"	20.50"
EXPOSED SURFACE	13.00"	15.00"	17.00"	19.00"	21.00"	8.00"	13.00"	18.00"	23.00"
SPECIFY MODEL	XLSC/XLPC 800	XLSC/XLPC 1000	XLSC/XLPC 1200	XLSC/XLPC 1400	XLSC/XLPC 1600	ESC 400	ESC 800	ESC 1200	ESC 1600

For odd and larger sized joints, call 800.233.8493 or visit [www.c-sgroup.com](http://www.c-sgroup.com)



# Roof Covers 2"-Up

C/S offers three types of roof covers for flat and built-up roofs. Our specialty MARC roof covers are designed for high movement and high wind loads. C/S Metal and Bellows roof covers expand and contract for multi-directional movement.

For use on flat or built-up roofs

Factory fabricated transitions to meet all roof/parapet conditions

Variety of finishes available

The cover's aluminum frames are designed to create a weather-tight seal on the underside of the sliding metal cover

Waterstop

Select models are available for purchase online. Go to [www.c-sgroup.com/buyejc](http://www.c-sgroup.com/buyejc) [BUY ONLINE](#)

For comprehensive information on these products, visit [www.c-sgroup.com/expansion-joint-covers](http://www.c-sgroup.com/expansion-joint-covers)

## ROOF COVERS

SRJ

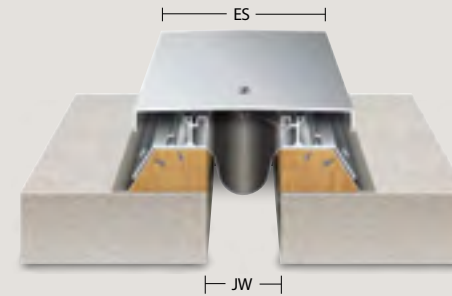

MARC



RJT

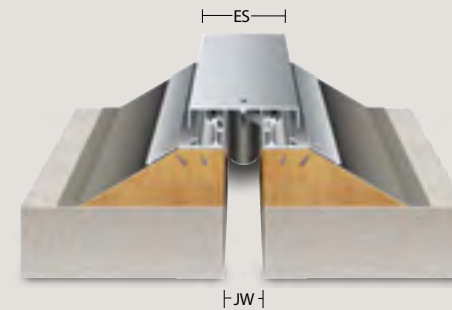

BRJ

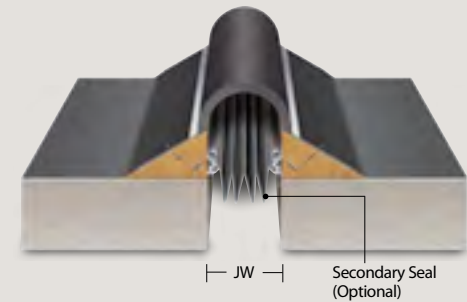

## MODEL DATA

ROOF TO ROOF COVERS															
JOINT WIDTH	2"	4"	6"	8"	10"	12"	14"	16"	4"	6"	8"	10"	12"	14"	16"
MINIMUM OPENING	0.00"	0.00"	0.00"	0.00"	0.00"	0.00"	0.00"	0.00"	1.00"	1.00"	1.00"	1.00"	1.00"	1.00"	1.00"
MAXIMUM OPENING	3.00"	6.00"	9.00"	12.00"	15.00"	18.00"	21.00"	24.00"	7.50"	11.75"	12.50"	16.75"	20.75"	21.00"	24.25"
EXPOSED SURFACE	N/A	N/A	N/A	N/A	N/A	N/A	N/A	N/A	12.00"	15.00"	18.00"	21.00"	24.00"	27.00"	30.00"
SPECIFY MODEL	BRJ 200	BRJ 400	BRJ 600	BRJ 800	BRJ 1000	BRJ 1200	BRJ 1400	BRJ 1600	SRJ 400	SRJ 600	SRJ 800	SRJ 1000	SRJ 1200	SRJ 1400	SRJ 1600
ROOF TO WALL COVERS															
JOINT WIDTH	2"	4"	6"	8"	10"	12"	14"	16"	4"	6"	8"	10"	12"	14"	16"
MINIMUM OPENING	0.00"	0.00"	0.00"	0.00"	0.00"	0.00"	0.00"	0.00"	0.00"	0.00"	4.50"	5.50"	6.50"	7.50"	8.50"
MAXIMUM OPENING	3.00"	6.00"	9.00"	12.00"	15.00"	18.00"	21.00"	24.00"	6.25"	8.75"	10.25"	13.25"	16.25"	17.50"	20.00"
EXPOSED SURFACE	N/A	N/A	N/A	N/A	N/A	N/A	N/A	N/A	8.00"	10.50"	13.00"	15.50"	18.00"	20.50"	23.00"
SPECIFY MODEL	BRJW 200	BRJW 400	BRJW 600	BRJW 800	BRJW 1000	BRJW 1200	BRJW 1400	BRJW 1600	SRJW 400	SRJW 600	SRJW 800	SRJW 1000	SRJW 1200	SRJW 1400	SRJW 1600

For odd and larger sized joints, call 800.233.8493 or visit [www.c-sgroup.com](http://www.c-sgroup.com)



# Parking Covers and Seals 1"-16"

*C/S parking joints covers are designed to eliminate problems associated with standard parking joints. C/S Zip Block seals install quickly without messy elastomeric concrete. C/S KB and PTC metal covers can handle constant rolling loads without breaking or loosening.*

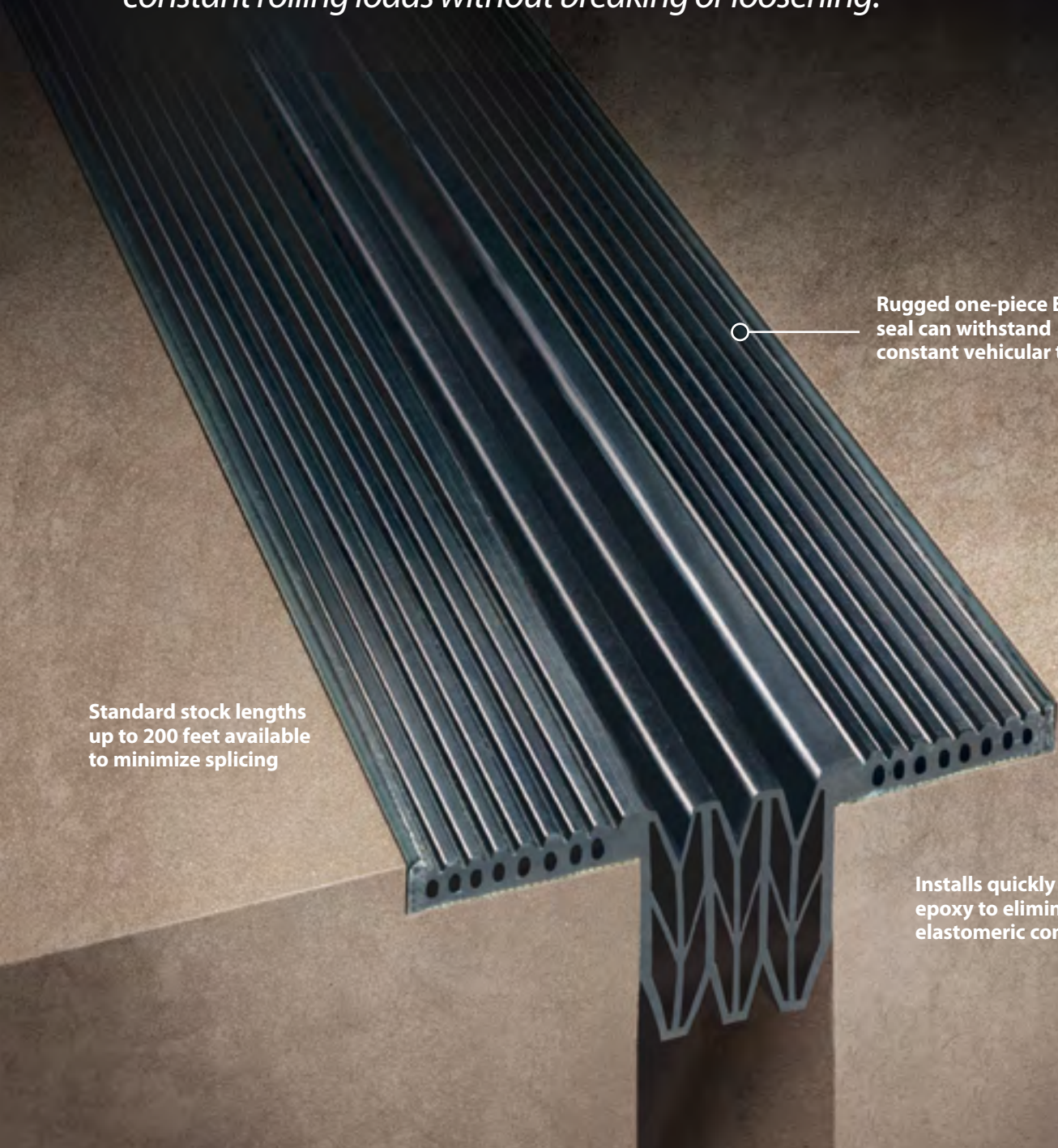

Rugged one-piece EPDM seal can withstand constant vehicular traffic

Standard stock lengths up to 200 feet available to minimize splicing

Installs quickly with epoxy to eliminate messy elastomeric concrete

## PARKING COVERS

ZB

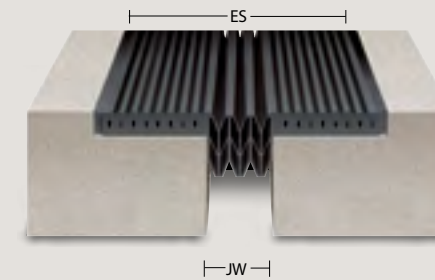

ZBSM

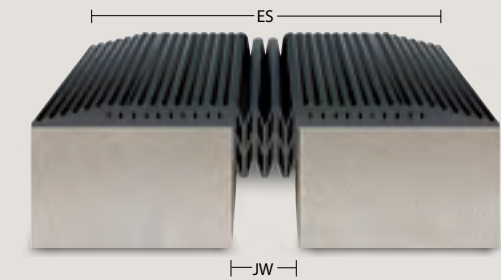

KB

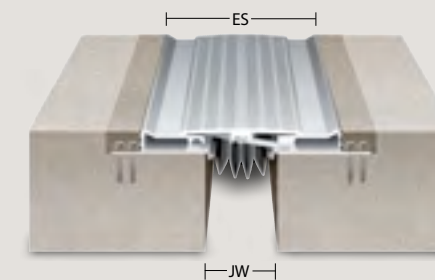

PTC

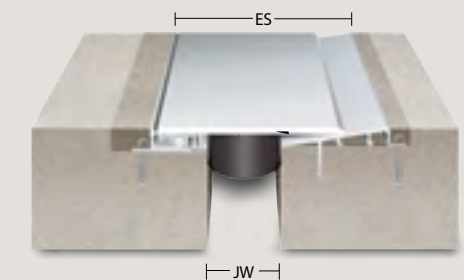

PDS

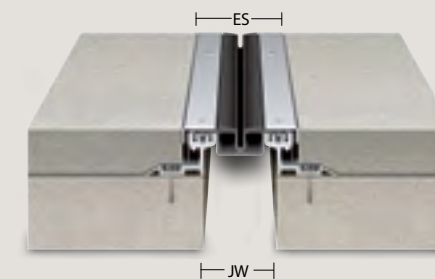

HB

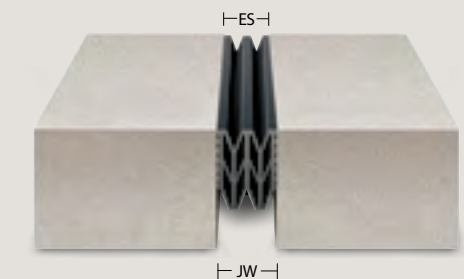

## MODEL DATA

### FLOOR TO FLOOR COVERS

JOINT WIDTH	4"	6"	8"	6"	8"	10"	12"	14"	16"	4"	6"	8"
MINIMUM OPENING	2.00"	2.00"	3.00"	0.00"	0.00"	0.00"	0.00"	0.00"	0.00"	3.00"	4.00"	5.50"
MAXIMUM OPENING	6.50"	9.50"	12.50"	11.00"	13.00"	16.00"	19.00"	22.00"	25.0"	5.25"	7.75"	10.25"
EXPOSED SURFACE	11.25"	16.25"	20.25"	19.63"	21.63"	24.63"	27.38"	30.38"	33.38"	7.63"	11.13"	14.13"
SPECIFY MODEL	KB 400	KB 600	KB 800	PTC 600	PTC 800	PTC 1000	PTC 1200	PTC 1400	PTC 1600	KBW 400	KBW 600	KBW 800

### FLOOR TO FLOOR COVERS

JOINT WIDTH	1.0"	2.0"	3.0"	4.0"	1.0"	2.0"	3.0"	4.0"	1.0"	2.0"	3.0"	4.0"
MINIMUM OPENING	0.50"	1.00"	1.50"	2.00"	0.50"	1.00"	1.50"	2.00"	0.00"	0.75"	1.75"	1.50"
MAXIMUM OPENING	1.50"	3.00"	4.50"	6.00"	1.50"	3.00"	4.50"	6.00"	2.25"	3.25"	4.25"	6.50"
EXPOSED SURFACE	8.00"	9.00"	10.00"	11.00"	1.00"	2.00"	3.00"	4.00"	4.75"	4.75"	4.75"	6.75"
SPECIFY MODEL	ZB 100	ZB 200	ZB 300	ZB 400	HB 100	HB 200	HB 300	HB 400	PDA-100	PDA-200	PDA-300	PDA-400

For odd and larger sized joints, call 800.233.8493 or visit [www.c-sgroup.com](http://www.c-sgroup.com)



For comprehensive information on these products, visit [www.c-sgroup.com/expansion-joint-covers](http://www.c-sgroup.com/expansion-joint-covers)

# No matter what joint cover you need, we've got the right fire barrier.

*When an expansion or seismic joint passes through a fire-rated structure, it is necessary to maintain the fire integrity of that structure.*

Maintaining the integrity of a 2" wide joint is quite simple; however, a joint designed for seismic movement up to 24 inches becomes a more difficult proposition. **In general, the wider the joint, the more complex the fire barrier.** C/S has simplified our fire barrier for small joint sizes for easy installation and to maximize cost effectiveness (see Reflex). Floor applications are relatively simple configurations regardless of joint size unless lateral shear is required. Walls can be more complex. **Variations in wall configurations** and transitions between adjacent fire barriers make it critical to consult the manufacturer. **C/S has a technical expert available to assist you in detailing these applications.** Current building codes

require fire barriers to limit the passing of heat and flame for 2, 3 and sometimes 4 hours, as well as accommodating the dynamic movement for which the joint was designed. ASTM E 1966 and UL 2079 specify criteria for "cycling" a fire barrier 500 times prior to fire testing.



### UL Testing

C/S tests all its fire barriers at Underwriters Laboratories (UL) because they represent the most stringent and universally accepted testing authority. UL 2079 cycling tests are included.

## REFLEX 1"-4" DETAILS



Stainless steel foil drape with block insulation affords maximum economy in material and installation. Wall barriers limited to 1"-4" joints and require no stainless foil.

NOMINAL JOINT WIDTH	C/S MODEL FLOORS	C/S MODEL GYPSUM WALL	C/S MODEL MASONRY WALL
1	RFX-1F	RFX-1W (GYP.)	RFX-1W (CONC)
	RFX-1F		RFX-1W (1 HR CONC)
2	RFX-2F	RFX-2W (GYP.)	RFX-2W (CONC)
	RFX-2F	RFX-2W (1 HR GYP.)	RFX-2W (1 HR CONC)
3	RFX-3F	RFX-3WC	RFX-3WC
4	RFX-4F	RFX-4WC	RFX-4WC

## MONOFLEX (OFX) 3"-20" & MULTIFLEX (MFX) 3"-12"



"Sandwich" assembly of layers of stainless steel foil and insulation contained in a stainless steel mesh. Multiflex should be used where lateral shear is required in floor applications having a 3"-12" joint width.

NOMINAL JOINT WIDTH	C/S MODEL FLOORS	C/S MODEL GYPSUM WALL	C/S MODEL MASONRY WALL
3-20	OFX-3F-20F	OFX-3W-20W (GYP)	OFX-3W-20W (CONC)
3-12	MFX-3F-12F	OFX-3W-12W (GYP)	OFX-3W-12W (CONC)

## FB97 13"-UP



Multiple drape configurations of stainless foil and insulation utilizing air pockets for additional insulation performance. Sliding frame available for 200% lateral shear applications in floors.

NOMINAL JOINT WIDTH	C/S MODEL FLOORS	C/S MODEL GYPSUM WALL	C/S MODEL MASONRY WALL
13-24	FB97-13-24	FB97-13-24 (GYP)	FB97-13-24 (CONC)
25-36	FB97-25-36	NA	NA
13-24	FB97-13(LS)-24(LS)	NA	NA
25-36	FB97-25(LS)-36(LS)	NA	NA

"LS" designation indicates a special adaptation of the floor fire barrier to accommodate lateral shear movement. FB-97 wall fire barriers naturally provide lateral shear movement.





**Construction Specialties™**

6696 State Route 405, Muncy, Pennsylvania 17756 U.S.A., 570.546.5941

895 Lakefront Promenade, Mississauga, Ontario L5E 2C2 Canada, 905.274.3611

🌐 [www.c-sgroup.com](http://www.c-sgroup.com)



### **The C/S Family of Products**

For more than 60 years, Construction Specialties has been a leader in architectural specialty products, including: Acrovyrn® Wall and Door Protection, Pedisystems® Entrance Flooring, Expansion Joint Covers, Cubicle Track and Curtains, Smoke and Explosion Venting Systems, Architectural Grilles, Architectural Louvers and Sun Controls.

We have operations throughout the world and can provide C/S products virtually anywhere. For a complete list of our international locations, visit [www.c-sgroup.com](http://www.c-sgroup.com).

*For the nearest C/S representative, or literature and samples, call toll free 800.233.8493 in U.S.A. and 888.895.8955 in Canada, or visit [www.c-sgroup.com](http://www.c-sgroup.com)*

©Copyright 2015 Construction Specialties, Inc.

Construction Specialties, Inc. reserves the right to make design changes or to withdraw any design without notice. Printed in U.S.A. Series 16

